

T8/A8

Original™ Series **PLASTIC** Pumps

EOM

Engineering
Operation &
Maintenance



Simplify your process



ACCUFLO™
SOLENOID PUMP TECHNOLOGY

TURBO-FLO™
PROGRESSIVE PUMP TECHNOLOGY

WILDEN®

A **DOVER** COMPANY

CE

WIL-10230-E-02
REPLACES WIL-10230-E-01

TABLE OF CONTENTS

	PAGE #
SECTION 1 — CAUTIONS	1
SECTION 2 — PUMP DESIGNATION SYSTEM	2
SECTION 3 — HOW IT WORKS (PUMP & AIR SYSTEMS)	3
SECTION 4 — DIMENSIONAL DRAWINGS	
A. T8 PLASTIC Air-Controlled	4
B. A8 PLASTIC Accu-Flo™	4
SECTION 5 — PERFORMANCE CURVES	
A. T8 PLASTIC Rubber-Fitted	5
B. T8 PLASTIC Ultra-Flex™-Fitted.....	5
C. T8 PLASTIC TPE-Fitted	6
D. T8 PLASTIC PTFE-Fitted	6
E. A8 PLASTIC Accu-Flo™ Rubber/TPE-Fitted.....	7
F. A8 PLASTIC Accu-Flo™ Rubber/TPE-Fitted 70/30 Operating Condition.....	7
G. A8 PLASTIC Accu-Flo™ Ultra-Flex™/PTFE-Fitted	8
H. A8 PLASTIC Accu-Flo™ Ultra-Flex™/PTFE-Fitted 70/30 Operating Condition	8
SECTION 6 — SUCTION LIFT CURVES & DATA	
A. T8 PLASTIC Air-Controlled	9
B. A8 PLASTIC Accu-Flo™	9
SECTION 7 — INSTALLATION & OPERATION	
A. Installation — Air-Controlled Pumps.....	10
B. Air-Controlled Operation and Maintenance	11
C. Accu-Flo™ Operating Principles	12
D. Installation — Accu-Flo™ Pumps.....	12
E. Accu-Flo™ Operation and Maintenance	13
F. Troubleshooting Air-Operated Pumps	14
G. Troubleshooting Accu-Flo™ Pumps.....	14
SECTION 8 — DIRECTIONS FOR DISASSEMBLY/REASSEMBLY	
A. T8 PLASTIC Wetted Path — Tools Required.....	15
B. Turbo-Flo™ Air Valve — Disassembly, Cleaning, Inspection	18
C. Reassembly Hints & Tips, Torque Specs.....	20
D. Gasket Kit Installation	21
SECTION 9 — EXPLODED VIEW/PARTS LISTING	
A. T8 PLASTIC Rubber/TPE-Fitted	22
B. T8 PLASTIC PTFE-Fitted	24
C. A8 PLASTIC Accu-Flo™	26
SECTION 10 — REFERENCE	
A. Elastomer Options	28
B. Accu-Flo™ Electrical Information	28

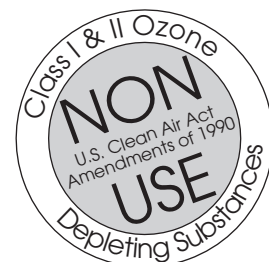

SECTION 1

T8 PLASTIC CAUTIONS – READ FIRST!



TEMPERATURE LIMITS:

Polypropylene	0°C to 79°C	32°F to 175°F
PVDF	-12°C to 107°C	10°F to 225°F
Neoprene	-17.8°C to 93.3°C	0°F to 200°F
Buna-N	-12.2°C to 82.2°C	10°F to 180°F
EPDM	-51.1°C to 137.8°C	-60°F to 280°F
Viton®	-40°C to 176.7°C	-40°F to 350°F
Wil-Flex™	-40°C to 107.2°C	-40°F to 225°F
Polyurethane	12.2°C to 65.6°C	10°F to 150°F
Saniflex™	-28.9°C to 104.4°C	-20°F to 220°F
PTFE	4.4°C to 104.4°C	40°F to 220°F
Tetra-Flex™ PTFE	4.4°C to 107.2°C	40°F to 225°F
W/Neoprene		
Tetra-Flex™ PTFE	-10°C to 137°C	14°F to 280°F
W/EPDM		
Tetra-Flex™ PTFE	4.4°C to 176.6°C	40°F to 350°F



CAUTION: When choosing pump materials, be sure to check the temperature limits for all wetted components. Example: Viton® has a maximum limit of 176.7°C (350°F) but polypropylene has a maximum limit of only 79°C (175°F).



CAUTION: Maximum temperature limits are based upon mechanical stress only. Certain chemicals will significantly reduce maximum safe operating temperatures. Consult engineering guide for chemical compatibility and temperature limits.



CAUTION: Always wear safety glasses when operating pump. If diaphragm rupture occurs, material being pumped may be forced out air exhaust.



WARNING: Prevention of static sparking — If static sparking occurs, fire or explosion could result. Pump, valves, and containers must be properly grounded when handling flammable fluids and whenever discharge of static electricity is a hazard.



CAUTION: Do not exceed 8.6 bar (125 psig) air supply pressure.



CAUTION: Before any maintenance or repair is attempted, the compressed air line to the pump should be disconnected and all air pressure allowed to bleed from pump. Disconnect all intake, discharge and air lines. Drain the pump by turning it upside down and allowing any fluid to flow into a suitable container.



CAUTION: Blow out air line for 10 to 20 seconds before attaching to pump to make sure all pipe line debris is clear. Use an in-line air filter. A 5µ (micron) air filter is recommended.



NOTE: When installing PTFE diaphragms, it is important to tighten outer pistons simultaneously (turning in opposite directions) to ensure tight fit.



NOTE: Tighten clamp bands and retainers prior to installation. Fittings may loosen during transportation.



NOTE: Before starting disassembly, mark a line from each liquid chamber to its corresponding air chamber. This line will assist in proper alignment during reassembly.



CAUTION: Verify the chemical compatibility of the process and cleaning fluid to the pump's component materials in the Chemical Resistance Guide (see E4).



NOTE: Pastic series pumps are made of virgin plastic and are not UV stabilized. Direct sunlight for prolonged periods can cause deterioration of plastics.



CAUTION: When removing the end cap using compressed air, the air valve end cap may come out with considerable force. Hand protection such as a padded glove or rag should be used to capture the end cap.



CAUTION: Only explosion proof (NEMA 7) solenoid valves should be used in areas where explosion proof equipment is required.



NOTE: Non lube-free pumps must be lubricated. Wilden suggests an arctic ISO grade 15 (5 weight oil). Do not over-lubricate air supply. Over-lubrication will reduce pump performance.

SECTION 2

WILDEN PUMP DESIGNATION SYSTEM

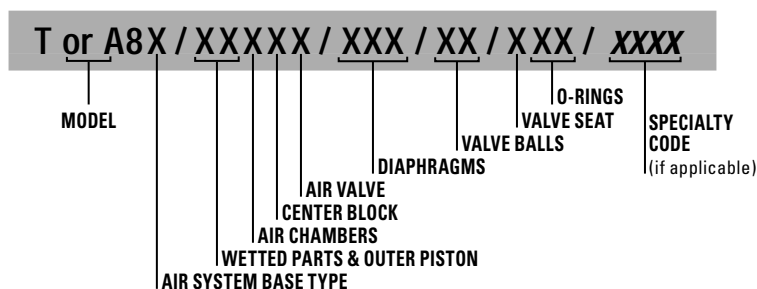

MODEL P2 METAL MATERIAL CODES

AIR SYSTEM BASE TYPE

T = TURBO-FLO™

WETTED PARTS & OUTER PISTON

PK = POLYPROPYLENE / PVDF
 PP = POLYPROPYLENE / POLYPROPYLENE

AIR CHAMBERS

A = ALUMINUM
 C = PTFE-COATED ALUMINUM
 N = NICKEL-PLATED ALUMINUM
 S = STAINLESS STEEL
 W = CAST IRON

CENTER BLOCK

A = ALUMINUM
 C = PTFE-COATED ALUMINUM
 N = NICKEL-PLATED ALUMINUM
 P = POLYPROPYLENE
 S = STAINLESS STEEL

AIR VALVE

A = ALUMINUM
 B = BRASS
 C = PTFE PFA COATED
 D = BRASS W/OIL BOTTLE
 N = NICKEL PLATED ALUMINUM
 S = STAINLESS STEEL

DIAPHRAGMS

BNS = BUNA-N (Red Dot)
 FSS = SANIFLEX™ [Hytrel® (Cream)]
 EPS = EPDM (Blue Dot)
 NES = NEOPRENE (Green Dot)
 PUS = POLYURETHANE (Clear)
 TEU = PTFE W/EPDM BACK-UP (White)
 TNU = PTFE W/NEOPRENE BACK-UP (White)
 TSU = PTFE W/SANIFLEX™ BACK-UP (White)
 BNU = BUNA-N, ULTRA-FLEX™ (Red Dot)
 EPU = EPDM, ULTRA-FLEX™ (Blue Dot)
 NEU = NEOPRENE, ULTRA-FLEX™ (Green Dot)
 VTU = VITON®, ULTRA-FLEX™ (White Dot)
 VTS = VITON® (White Dot)
 WFS = WIL-FLEX™ [Santoprene® (Orange Dot)]

VALVE BALL

BN = BUNA-N (Red Dot)
 FS = SANIFLEX™ [Hytrel® (Cream)]
 EP = EPDM (Blue Dot)
 NE = NEOPRENE (Green Dot)
 PU = POLYURETHANE (Brown)
 TF = PTFE (White)
 VT = VITON® (White Dot)
 WF = WIL-FLEX™ [Santoprene® (Orange Dot)]

VALVE SEAT

K = PVDF
 P = POLYPROPYLENE

VALVE SEAT O-RING

BN = BUNA-N
 PU = POLYURETHANE
 TV = PTFE ENCAP. VITON®
 WF = WIL-FLEX™ [Santoprene® (Orange Dot)]

SPECIALTY CODES

0100 Wil-Gard II™ 110V	0168 Accu-Flo™, 110V AC coil, Wil-Gard II™ 110V	0362 Accu-Flo™, 110V AC coil, PFA coated hardware, Wil-Gard II™ 110V
0102 Wil-Gard II™, sensor wires ONLY	0169 Accu-Flo™, 110V AC coil, PFA coated hardware	0363 Accu-Flo™, 110V AC coil, Stallion® internals (balls & seats)
0103 Wil-Gard II™ 220V	0170 Accu-Flo™, 110V AC x-proof coil, PFA coated hardware	0502 PFA coated hardware
0145 Accu-Flo™, 110V AC x-proof coil, Wil-Gard II™ 110V	0180 Accu-Flo™, 24V AC / 12V DC coil, PFA coated hardware	0513 SS outer pistons
0150 Accu-Flo™, 24V DC coil	0181 Accu-Flo™, 24V AC / 12V DC x-proof coil, PFA coated hardware	0560 Split manifold
0151 Accu-Flo™, 24V AC / 12V DC coil	0183 Accu-Flo™, 24V AC / 12V DC x-proof coil, Wil-Gard II™ 110V	0561 Split manifold, PFA coated hardware
0153 Accu-Flo™, 24V AC / 12V DC x-proof coil	0184 Accu-Flo™, 24V DC coil, PFA coated hardware	0563 Split manifold, discharge ONLY
0154 Accu-Flo™, 24V DC x-proof coil	0185 Accu-Flo™, 24V DC x-proof coil, PFA coated hardware	0564 Split manifold, inlet ONLY
0155 Accu-Flo™, 110V AC coil	0206 PFA coated hardware, Wil-Gard II™ sensor wires ONLY	0608 PFA coated hardware, Wil-Gard II™ 220V
0156 Accu-Flo™, 110V AC x-proof coil	0360 Accu-Flo™, 24V DC coil, DIN flange	0660 Split manifold, Wil-Gard II™ 110V
0157 Accu-Flo™, 24V DC coil, international, PTB approved		0661 Split manifold, PFA coated hardware, Wil-Gard II™ 110V
0164 Accu-Flo™, 110V AC coil, Wil-Gard sensor wires only		

NOTE: MOST ELASTOMERIC MATERIALS USE COLORED DOTS FOR IDENTIFICATION.

Viton is a registered trademarks of DuPont Dow Elastomers.

SECTION 3

THE WILDEN PUMP — HOW IT WORKS

The Wilden diaphragm pump is an air-operated, positive displacement, self-priming pump. These drawings show the flow pattern through the pump upon its initial stroke. It is assumed the pump has no fluid in it prior to its initial stroke.

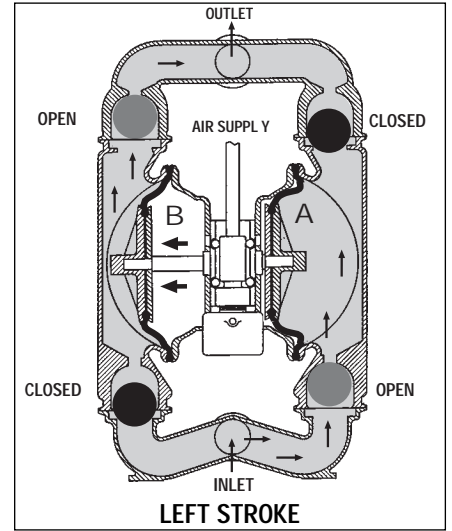
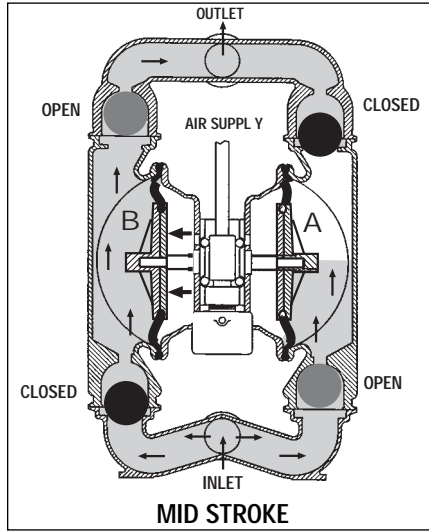
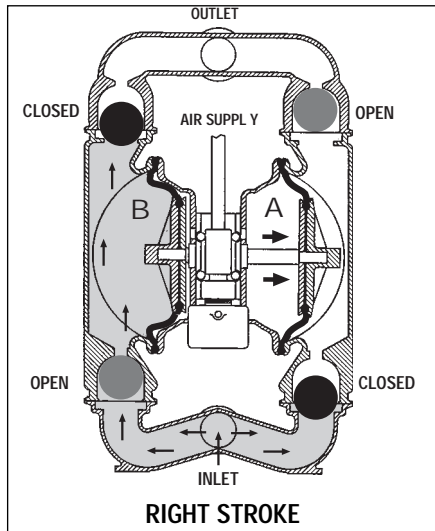

FIGURE 1 The air valve directs pressurized air to the back side of diaphragm A. The compressed air is applied directly to the liquid column separated by elastomeric diaphragms. The diaphragm acts as a separation membrane between the compressed air and liquid, balancing the load and removing mechanical stress from the diaphragm. The compressed air moves the diaphragm away from the center block of the pump. The opposite diaphragm is pulled in by the shaft connected to the pressurized diaphragm. Diaphragm B is on its suction stroke; air behind the diaphragm has been forced out to the atmosphere through the exhaust port of the pump. The movement of diaphragm B toward the center block of the pump creates a vacuum within chamber B. Atmospheric pressure forces fluid into the inlet manifold forcing the inlet valve ball off its seat. Liquid is free to move past the inlet valve ball and fill the liquid chamber (see shaded area).

FIGURE 2 When the pressurized diaphragm, diaphragm A, reaches the limit of its discharge stroke, the air valve redirects pressurized air to the back side of diaphragm B. The pressurized air forces diaphragm B away from the center block while pulling diaphragm A to the center block. Diaphragm B is now on its discharge stroke. Diaphragm B forces the inlet valve ball onto its seat due to the hydraulic forces developed in the liquid chamber and manifold of the pump. These same hydraulic forces lift the discharge valve ball off its seat, while the opposite discharge valve ball is forced onto its seat, forcing fluid to flow through the pump discharge. The movement of diaphragm A toward the center block of the pump creates a vacuum within liquid chamber A. Atmospheric pressure forces fluid into the inlet manifold of the pump. The inlet valve ball is forced off its seat allowing the fluid being pumped to fill the liquid chamber.

FIGURE 3 At completion of the stroke, the air valve again redirects air to the back side of diaphragm A, which starts diaphragm B on its exhaust stroke. As the pump reaches its original starting point, each diaphragm has gone through one exhaust and one discharge stroke. This constitutes one complete pumping cycle. The pump may take several cycles to completely prime depending on the conditions of the application.

SECTION 5A

PERFORMANCE CURVES T8 PLASTIC RUBBER-FITTED

Height..... 770 mm (30.3")
 Width..... 490 mm (19.3")
 Depth 333 mm (13.1")
 Est. Ship Weight.....Polypropylene 35 kg (77 lbs)
 Air Inlet..... 19 mm (3/4")
 Inlet..... 51 mm (2")
 Outlet 51 mm (2")
 Suction Lift 2.7 m Dry (9.0')
 9.5 m Wet (31.0')

Displacement / Stroke 2.84 l (0.75gal.)
 Max. Flow Rate..... 579 lpm (153 gpm)
 Max. Size Solids 6.4 mm (1/4")

*Displacement per stroke was calculated at 4.8 bar (70 psig) air inlet pressure against a 2 bar (30 psig) head pressure.
Example: To pump 303 lpm (80 gpm) against a discharge pressure head of 2 bar (30 psig) requires 4.1 bar (60 psig) and 80 Nm³/h (47 scfm) air consumption. (See dot on chart.)

Caution: Do not exceed 8.6 bar (125 psig) air supply pressure.

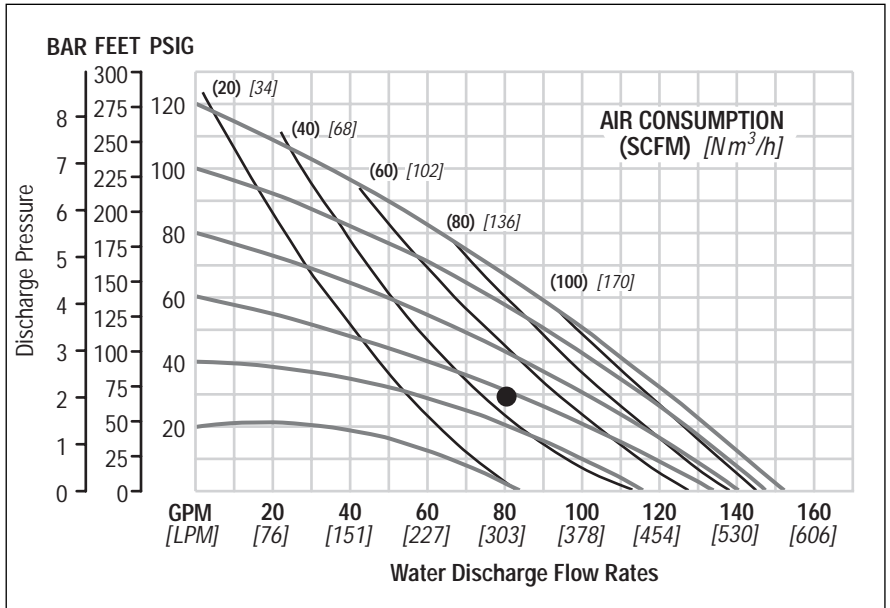

Flow rates indicated on chart were determined by pumping water.

For optimum life and performance, pumps should be specified so that daily operation parameters will fall in the center of the pump performance curve.

SECTION 5B

PERFORMANCE CURVES T8 PLASTIC ULTRA-FLEX™-FITTED

Height..... 770 mm (30.3")
 Width..... 490 mm (19.3")
 Depth 333 mm (13.1")
 Est. Ship Weight.....Polypropylene 35 kg (77 lbs)
 Air Inlet..... 19 mm (3/4")
 Inlet..... 51 mm (2")
 Outlet 51 mm (2")
 Suction Lift 3.4 m Dry (11')
 9.1 m Wet (30')

Displacement / Stroke 1.74 l (0.46 gal.)
 Max. Flow Rate..... 556 lpm (147 gpm)
 Max. Size Solids 6.4 mm (1/4")

*Displacement per stroke was calculated at 4.8 bar (70 psig) air inlet pressure against a 2 bar (30 psig) head pressure.

Example: To pump 303 lpm (80 gpm) against a discharge pressure head of 2 bar (30 psig) requires 4.1 bar (60 psig) and 82 Nm³/h (48 scfm) air consumption. (See dot on chart.)

Caution: Do not exceed 8.6 bar (125 psig) air supply pressure.

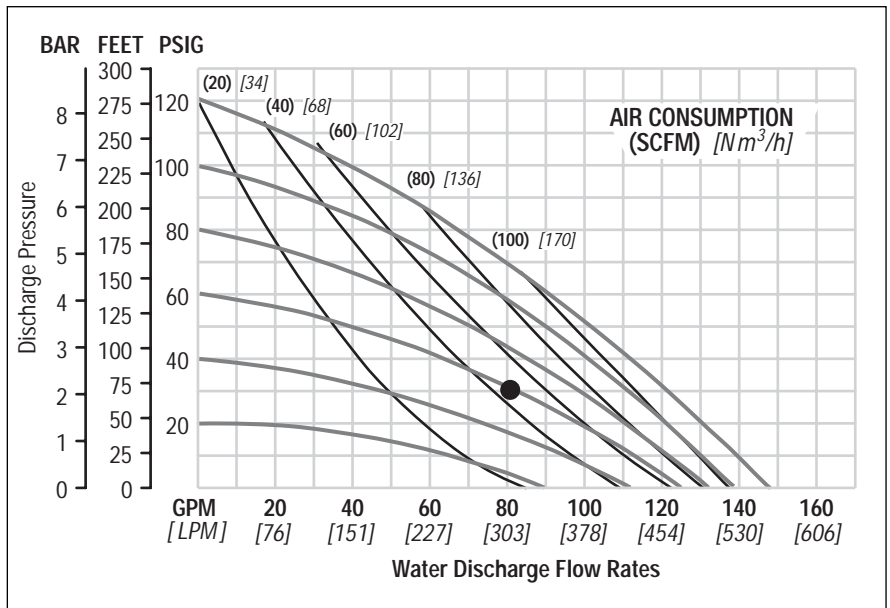

Flow rates indicated on chart were determined by pumping water.

For optimum life and performance, pumps should be specified so that daily operation parameters will fall in the center of the pump performance curve.

SECTION 5C

PERFORMANCE CURVES T8 PLASTIC TPE-FITTED

Height..... 770 mm (30.3")
 Width..... 490 mm (19.3")
 Depth 333 mm (13.1")
 Est. Ship Weight..... Polypropylene 35 kg (77 lbs)
 Air Inlet..... 19 mm (3/4")
 Inlet..... 51 mm (2")
 Outlet 51 mm (2")
 Suction Lift 4.6 m Dry (15')
 9.5 m Wet (31')

Displacement / Stroke 2.91 l (0.77 gal.)¹
 Max. Flow Rate..... 591 lpm (156 gpm)
 Max. Size Solids 6.4 mm (1/4")

¹Displacement per stroke was calculated at 4.8 bar (70 psig) air inlet pressure against a 2 bar (30 psig) head pressure.

Example: To pump 322 lpm (85 gpm) against a discharge pressure head of 2 bar (30 psig) requires 4.1 bar (60 psig) and 85 Nm³/h (50 scfm) air consumption. (See dot on chart.)

Caution: Do not exceed 8.6 bar (125 psig) air supply pressure.

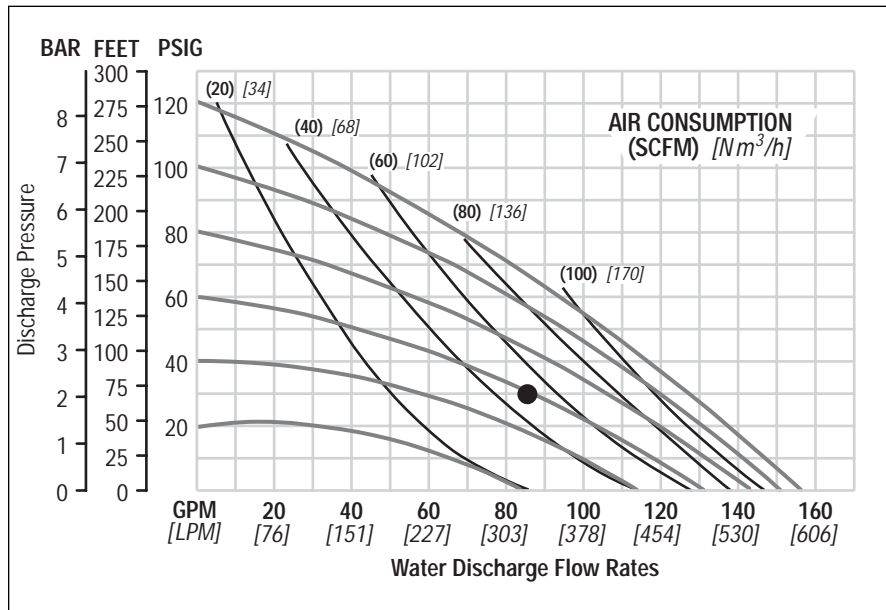

Flow rates indicated on chart were determined by pumping water.

For optimum life and performance, pumps should be specified so that daily operation parameters will fall in the center of the pump performance curve.

SECTION 5D

PERFORMANCE CURVES T8 PLASTIC PTFE-FITTED

Height..... 770 mm (30.3")
 Width..... 490 mm (19.3")
 Depth 333 mm (13.1")
 Est. Ship Weight..... Polypropylene 35 kg (77 lbs)
 Air Inlet..... 19 mm (3/4")
 Inlet..... 51 mm (2")
 Outlet 51 mm (2")
 Suction Lift 3.1 m Dry (10')
 9.5 m Wet (31')

Displacement / Stroke 1.51 l (0.40 gal.)¹
 Max. Flow Rate..... 458 lpm (121 gpm)
 Max. Size Solids 6.4 mm (1/4")

¹Displacement per stroke was calculated at 4.8 bar (70 psig) air inlet pressure against a 2 bar (30 psig) head pressure.

Example: To pump 265 lpm (70 gpm) against a discharge pressure head of 2 bar (30 psig) requires 4.1 bar (60 psig) and 93.5 Nm³/h (55 scfm) air consumption. (See dot on chart.)

Caution: Do not exceed 8.6 bar (125 psig) air supply pressure.

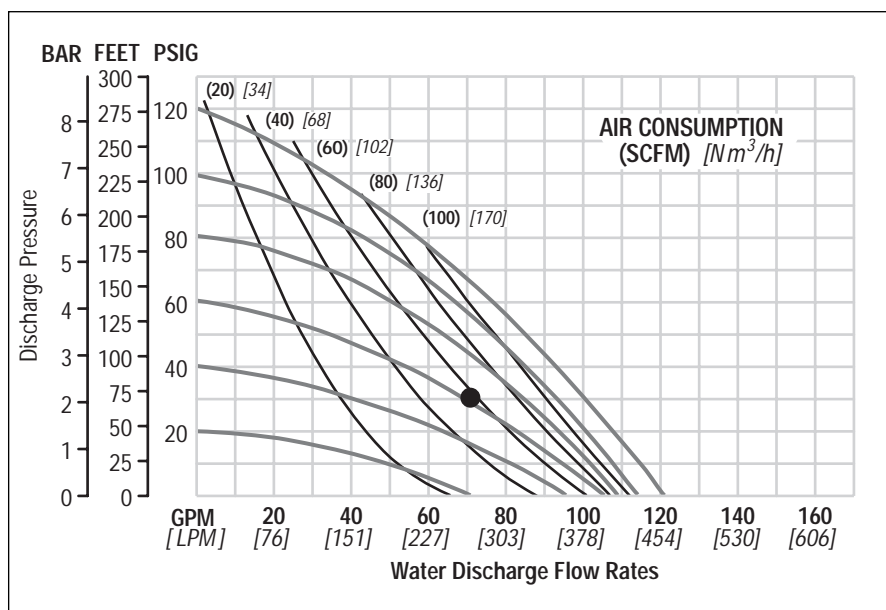

Flow rates indicated on chart were determined by pumping water.

For optimum life and performance, pumps should be specified so that daily operation parameters will fall in the center of the pump performance curve.

SECTION 5G

PERFORMANCE CURVES

A8 PLASTIC ACCU-FLO™ ULTRA-FLEX™/PTFE-FITTED

Height..... 770 mm (30.3")
 Width..... 490 mm (19.3")
 Depth 333 mm (13.1")
 Est. Ship Weight..... Polypropylene 34 kg (75 lbs)
 PVDF 43 kg (95 lbs)
 Air Inlet..... 19 mm (3/4")
 Inlet 51 mm (2")
 Outlet 51 mm (2")
 Suction Lift 3.4 m Dry (11')
 8.5 m Wet (28')
 Displacement / Stroke 1.74 l (0.46 gal.)¹
 Max. Flow Rate..... 386 lpm (102 gpm)
 Max. Size Solids 6.4 mm (1/4")

¹Displacement per stroke was calculated at 4.8 bar (70 psig) air inlet pressure against a 2 bar (30 psig) head pressure.

Example: To pump 189 lpm (50 gpm) against a discharge pressure head of 2.7 bar (40 psig) requires 5.5 bar (80 psig) inlet air pressure, 85 Nm³/h (50 scfm) air consumption and a pump speed of 120 strokes/minute. (See dot on chart.)

Caution: Do not exceed 8.6 bar (125 psig) air supply pressure.

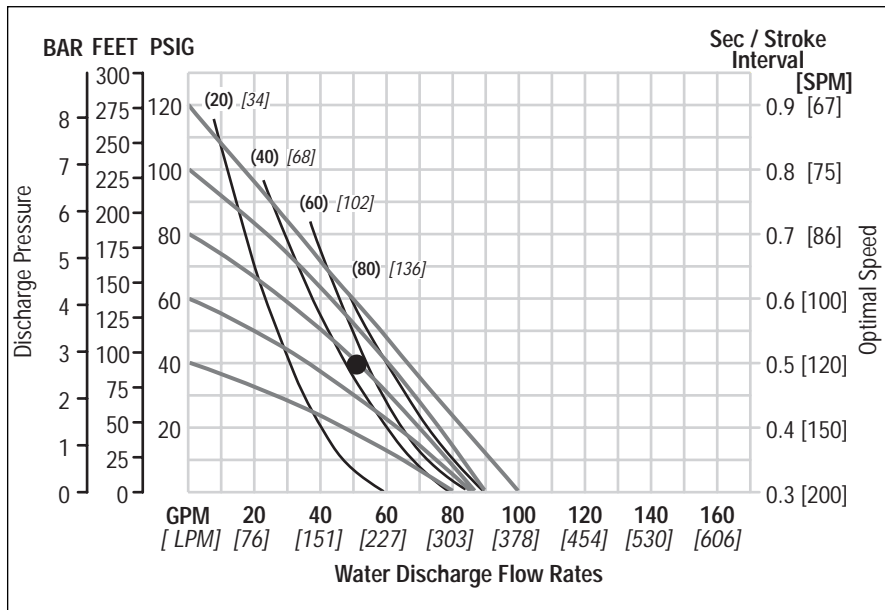

Flow curves are for "optimal speed" conditions only. The "optimal speed" is that speed which provides the maximum flow under a particular air and fluid pressure condition. The optimal speed varies for different fluid and air pressures. Recommendations for optimal speed can be found on the right side of the flow curve.

Flow rates indicated on chart were determined by pumping water.

For optimum life and performance, pumps should be specified so that daily operation parameters will fall in the center of the pump performance curve.

SECTION 5H

70/30 OPERATING CONDITION

A8 PLASTIC ACCU-FLO™ ULTRA-FLEX™-PTFE-FITTED

This curve demonstrates the flow created when the stroke rate is modified under a static air and fluid pressure condition. This curve can be applied to different pressure conditions to estimate the change in flow due to stroke rate.

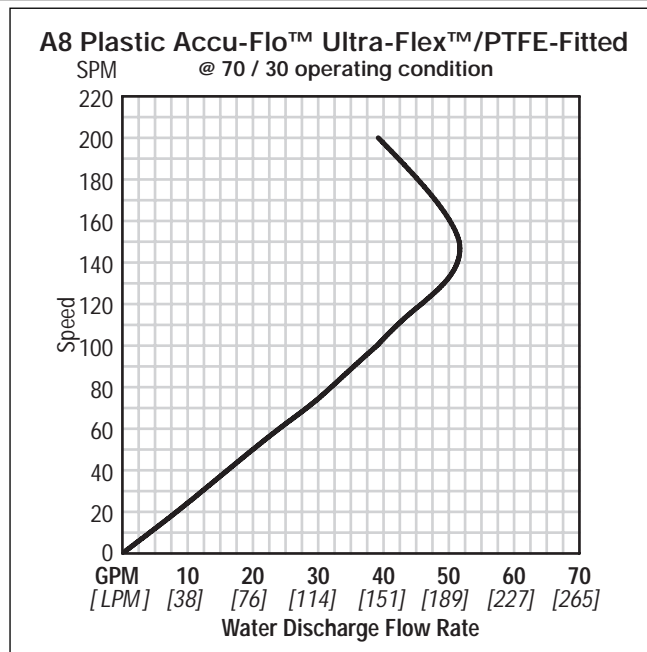

SECTION 6A

SUCTION LIFT CURVES & DATA

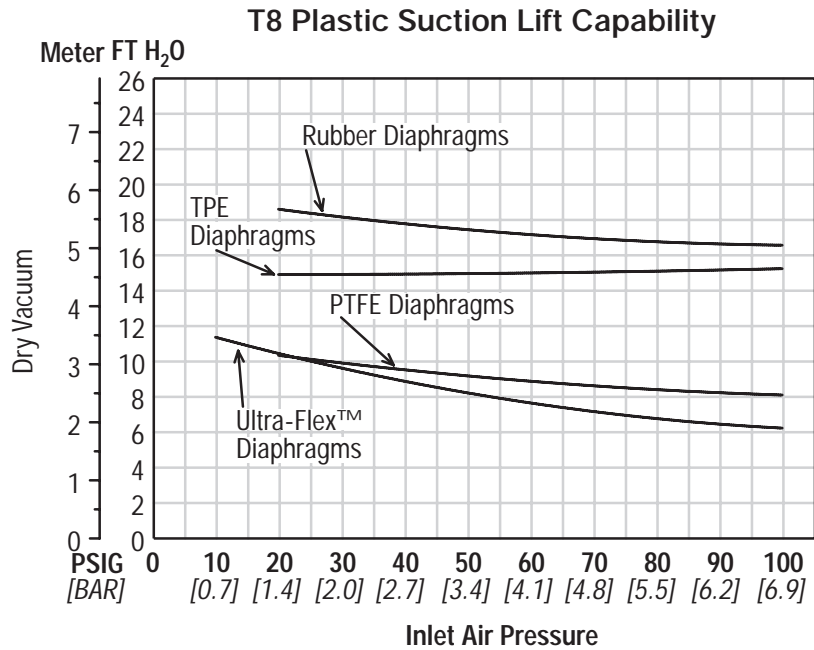

Suction lift curves are calibrated for pumps operating at 305 m (1,000') above sea level. This chart is meant to be a guide only. There are many variables which can affect your pump's operating characteristics. The number of intake

and discharge elbows, viscosity of pumping fluid, elevation (atmospheric pressure) and pipe friction loss all affect the amount of suction lift your pump will attain.

SECTION 6B

SUCTION LIFT CURVES & DATA

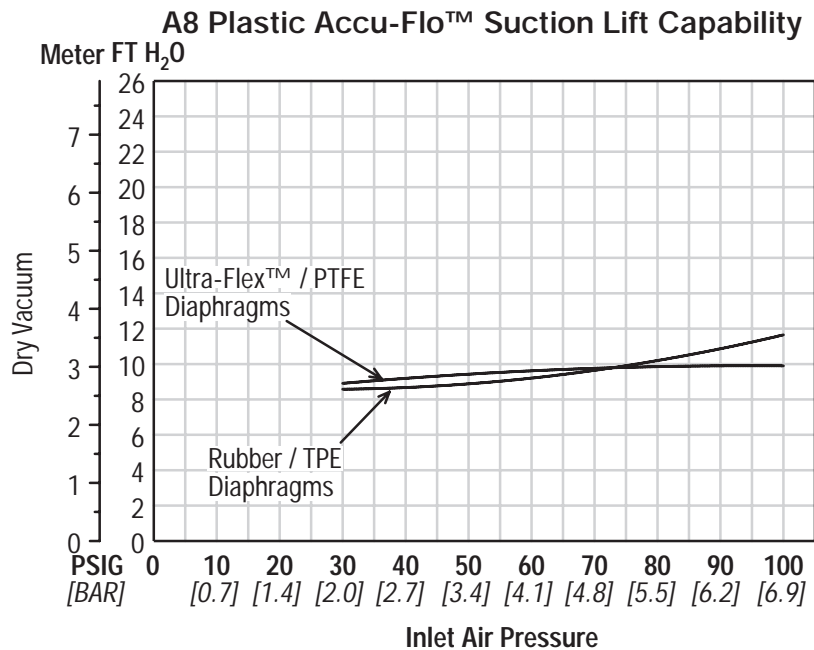

The solenoid was running at 150 strokes / minute.
Actual suction lift may vary with different pump speeds.

Suction lift curves are calibrated for pumps operating at 305 m (1,000') above sea level. This chart is meant to be a guide only. There are many variables which can affect your pump's operating characteristics. The number of intake

and discharge elbows, viscosity of pumping fluid, elevation (atmospheric pressure) and pipe friction loss all affect the amount of suction lift your pump will attain.

SECTION 7A

INSTALLATION – T8 PLASTIC AIR-OPERATED PUMPS

The Model T8 plastic pump has a 51 mm (2") inlet and 51 mm (2") outlet and is designed for flows to 591 lpm (156 gpm). The T8 plastic pump is manufactured with wetted parts of polypropylene. The center block of the T8 is constructed of glass-filled polypropylene. A variety of diaphragms, valve balls, valve seats, and o-rings are available to satisfy temperature, chemical compatibility, abrasion and flex concerns.

The suction pipe size should be at least 51 mm (2") diameter or larger if highly viscous material is being pumped. The suction hose must be non-collapsible, reinforced type as the T8 is capable of pulling a high vacuum. Discharge piping should be at least 51 mm (2"); larger diameter can be used to reduce friction losses. It is critical that all fittings and connections are airtight or a reduction or loss of pump suction capability will result.

For T8 plastic models, Wilden offers 68 kg (150 lb.) standard or metric flanges. The following details should be noted when mating these to piping:

- A 60–80 shore gasket that covers the entire flange face should be used.
- The gasket should be between .075" and .175" thickness.
- Mating flanges with flat as opposed to raised surfaces should be used for proper mechanical sealing.
- The flanges should be tightened to a minimum of 6.8 N•m (5 ft-lbs) but no more than 13.6 N•m (10 ft-lbs).

A non-raised surfaced-flange adapter should be utilized when mating to the pump's inlet and discharge manifolds for proper sealing.

INSTALLATION: Months of careful planning, study, and selection efforts can result in unsatisfactory pump performance if installation details are left to chance.

Premature failure and long term dissatisfaction can be avoided if reasonable care is exercised throughout the installation process.

LOCATION: Noise, safety, and other logistical factors usually dictate that "utility" equipment be situated away from the production floor. Multiple installations with conflicting requirements can result in congestion of utility areas, leaving few choices for siting of additional pumps.

Within the framework of these and other existing conditions, every pump should be located in such a way that four key factors are balanced against each other to maximum advantage.

ACCESS: First of all, the location should be accessible. If it's easy to reach the pump, maintenance personnel will have an easier time carrying out routine inspections and adjustments. Should major repairs become necessary, ease of access can play a key role in speeding the repair process and reducing total downtime.

AIR SUPPLY: Every pump location should have an air line large enough to supply the volume of air necessary to achieve the desired pumping rate (see pump performance chart). Use air pressure up to a maximum of 8.6 bar (125 psig) depending upon pumping requirements. The use of an air filter before the pump will ensure that the majority of any pipeline contaminants will be eliminated. For best results, the pumps should use an air filter, regulator, and lubricator system.

ELEVATION: Selecting a site that is well within the pump's suction lift capability will assure that loss-of-prime troubles will be eliminated. In addition, pump efficiency can be adversely affected if proper attention is not given to elevation (see pump performance chart).

PIPING: Final determination of the pump site should not be made until the piping problems of each possible location have been evaluated. The impact of current and future installations should be considered ahead of time to make sure that inadvertent restrictions are not created for any remaining sites.

The best choice possible will be a site involving the shortest and the straightest hook-up of suction and discharge piping. Unnecessary elbows, bends, and fittings should be avoided. Pipe sizes should be selected so as to keep friction losses within practical limits. All piping should be supported independently of the pump. In addition, it should line up without placing stress on the pump fittings.

Expansion joints can be installed to aid in absorbing the forces created by the natural reciprocating action of the pump. If the pump is to be bolted down to a solid foundation, a mounting pad placed between the pump and foundation will assist in minimizing pump vibration. Flexible connections between the pump and rigid piping will also assist in minimizing pump vibration. If quick-closing valves are installed at any point in the discharge system, or if pulsation within a system becomes a problem, a surge suppressor should be installed to protect the pump, piping and gauges from surges and water hammer.

When pumps are installed in applications involving flooded suction or suction head pressures, a gate valve should be installed in the suction line to permit closing of the line for pump service.

The T8 can be used in submersible applications only when both wetted and non-wetted portions are compatible with the material being pumped. If the pump is to be used in a submersible application, a hose should be attached to the pump's air exhaust and the exhaust air piped above the liquid level.

If the pump is to be used in a self-priming application, be sure that all connections are airtight and that the suction lift is within the pump's ability. Note: Materials of construction and elastomer material have an effect on suction lift parameters. Please refer to pump performance data.

Pumps in service with a positive suction head are most efficient when inlet pressure is limited to 0.5–0.7 bar (7–10 psig). Premature diaphragm failure may occur if positive suction is 0.8 bar (11 psig) and higher.

THE MODEL T8 WILL PASS 6.4 mm (1/4") SOLIDS. WHENEVER THE POSSIBILITY EXISTS THAT LARGER SOLID OBJECTS MAY BE SUCKED INTO THE PUMP, A STRAINER SHOULD BE USED ON THE SUCTION LINE.

CAUTION: DO NOT EXCEED 8.6 BAR (125 PSIG) AIR SUPPLY PRESSURE.

BLOW OUT AIR LINE FOR 10 TO 20 SECONDS BEFORE ATTACHING TO PUMP TO MAKE SURE ALL PIPE LINE DEBRIS IS CLEAR. ALWAYS USE AN IN-LINE AIR FILTER.

PUMPS SHOULD BE THOROUGHLY FLUSHED WITH WATER BEFORE INSTALLING INTO PROCESS LINES. FDA AND USDA APPROVED PUMPS SHOULD BE CLEANED AND/OR SANITIZED BEFORE BEING USED ON EDIBLE PRODUCTS.

SUGGESTED INSTALLATION

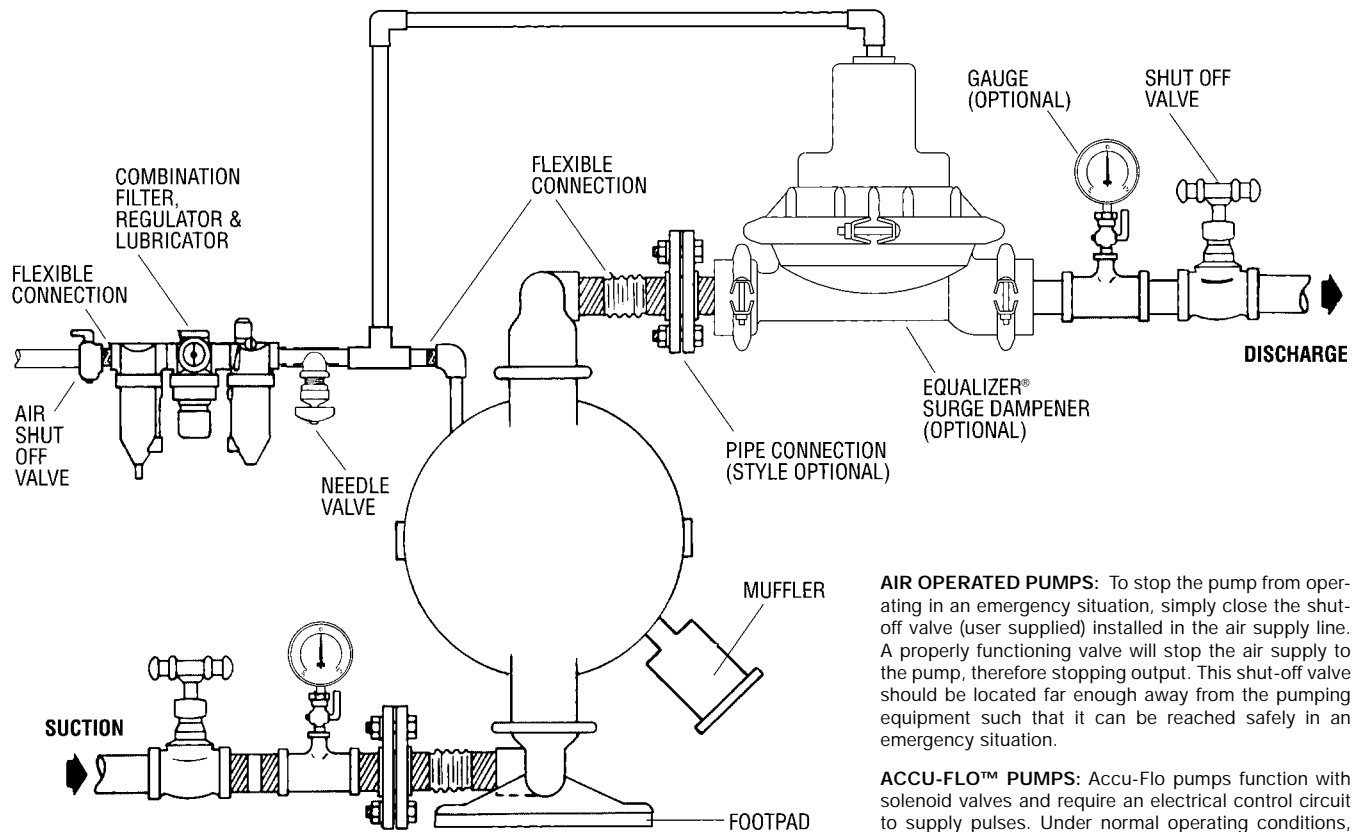

NOTE: In the event of a power failure, the shutoff valve should be closed, if the restarting of the pump is not desirable once power is regained.

AIR OPERATED PUMPS: To stop the pump from operating in an emergency situation, simply close the shut-off valve (user supplied) installed in the air supply line. A properly functioning valve will stop the air supply to the pump, therefore stopping output. This shut-off valve should be located far enough away from the pumping equipment such that it can be reached safely in an emergency situation.

ACCU-FLO™ PUMPS: Accu-Flo pumps function with solenoid valves and require an electrical control circuit to supply pulses. Under normal operating conditions, the control circuit is sufficient for starting and stopping the pump. However, the shut-off valve (user supplied) installed in the air supply line can be used to stop the pump if necessary. Therefore, it should be located far enough away from the pumping equipment such that it can be reached safely in an emergency situation.

SECTION 7B – AIR OPERATION

SUGGESTED OPERATION AND MAINTENANCE INSTRUCTIONS

OPERATION: Pump discharge rate can be controlled by limiting the volume and/or pressure of the air supply to the pump (preferred method). An air regulator is used to regulate air pressure. A needle valve is used to regulate volume. Pump discharge rate can also be controlled by throttling the pump discharge by partially closing a valve in the discharge line of the pump. This action increases friction loss which reduces flow rate. This is useful when the need exists to control the pump from a remote location. When the pump discharge pressure equals or exceeds the air supply pressure, the pump will stop; no bypass or pressure relief valve is needed, and pump damage will not occur. The pump has reached a “deadhead” situation and can be restarted by reducing the fluid discharge pressure or increasing the air inlet pressure. The Wilden T8 pump runs solely on compressed air and does not generate heat, therefore your process fluid temperature will not be affected.

RECORDS: When service is required, a record should be made of all necessary repairs and replacements. Over a period of time, such records can become a valuable tool for predicting and preventing future maintenance problems and unscheduled downtime. In addition, accurate records make it possible to identify pumps that are poorly suited to their applications.

MAINTENANCE AND INSPECTIONS: Since each application is unique, maintenance schedules may be different for every pump. Frequency of use, line pressure, viscosity and abrasiveness of process fluid all affect the parts life of a Wilden pump. Periodic inspections have been found to offer the best means for preventing unscheduled pump downtime. Personnel familiar with the pump’s construction and service should be informed of any abnormalities that are detected during operation.

SECTION 7C

OPERATING PRINCIPLES BEHIND ACCU-FLO™ PUMPS

In Accu-Flo™ pump models, the standard air valve is replaced with a two position, four-way solenoid valve that has a single operator and spring return. The valve is internally air piloted for longer coil and operator life.

When the solenoid is unpowered, one air chamber is pressurized with air, while the opposite chamber is exhausted. When electric power is applied, the solenoid shifts, and the pressurized air chamber is exhausted while the opposite chamber is pressurized. By alternately applying and removing power, the solenoid-operated pump runs like a standard Wilden pump.

The speed of the pump is controlled electrically. Since each stroke is controlled by an electrical signal, the pump is ideal for batching and other electrically controlled dispensing applications.

Although the speed of the pump is controlled electrically, the air pressure is important. Air pressure displaces the fluid, and if the pressure is insufficient to complete the physical stroke before an electronic impulse signals the pump to shift, the stroke will not be completed, and the displacement per stroke will be reduced. This does not harm the unit in any way, but it may cause inaccuracy when attempting to batch specific quantities with high precision if this effect is not taken into account.

There are three coil voltage options available. One coil allows for 24V DC operation. The second coil option allows for operation with either 12V DC or 24V AC at 60 Hz and the third coil option allows for 110V AC operation.

SECTION 7D

INSTALLATION – A8 PLASTIC ACCU-FLO™ PUMPS

Before installing your A8 Accu-Flo™ pump, review Section 7A for general installation suggestions including Location, Access, Air Supply, Elevation, and Piping.

The Accu-Flo™ Model A8 has a 51 mm (2") inlet and 51 mm (2") outlet and is designed for flows to 420 lpm (111 gpm). This maximum flow rate was calculated at 300 strokes per minute with 100 psig air inlet against 0 psig discharge head. The A8 Plastic pump is manufactured with wetted parts of polypropylene or PVDF. The center section of the A8 Plastic pump is of aluminum or polypropylene construction. A variety of diaphragms, valve balls, and o-rings are available to satisfy temperature, chemical compatibility, abrasion and flex concerns.

All wiring used to operate the pump should be placed and connected according to the proper electrical codes. It is important that the wiring is of adequate gauge to carry the current required to operate the pump. In addition, it is necessary that the electrical power supply is large enough to supply the current required to operate the pump. Wiring should be above ground level if possible (in case of fluid spill or leakage), and all wiring and connections which could become wet or damp should be made watertight.

If the pump is to be used in a self-priming application, be sure that all connections are airtight and that the suction lift is within the pump's ability. Note: Materials of construction and elastomer material have an effect on suction lift parameters. Please refer to pump performance data.

Pumps in service with a positive suction head are most efficient when inlet pressure is limited to 0.5–0.7 bar (7–10 psig). Premature diaphragm failure may occur if positive suction head is 0.8 bar (11 psig) and higher.

The solenoid valve is rated for continuous duty; however, stopping on an even number stroke count insures that the electrical power is off when pump is stopped. This practice is safer and also eliminates unwanted strokes when the system is shut down and electrical power is off.

THE MODEL A8 WILL PASS 6.4 mm (1/4") SOLIDS. WHENEVER THE POSSIBILITY EXISTS THAT LARGER SOLID OBJECTS MAY BE SUCKED INTO THE PUMP, A STRAINER SHOULD BE USED ON THE SUCTION LINE.

WARNING: Before installation, consult chart in Section 10B to ensure proper electrical connection.

WARNING: The solenoid valve should not be used in an area where explosion proof equipment is required unless NEMA 7 valve is specified.

There are three coil options available in both NEMA 4 and NEMA 7 ratings. One coil allows for 110V AC operation, one allows for 24V DC operation, and the third allows for either 24V AC or 12V DC operation. See Section 10B for options and part numbers.

ACCU-FLO™ ELECTRICAL CONNECTIONS

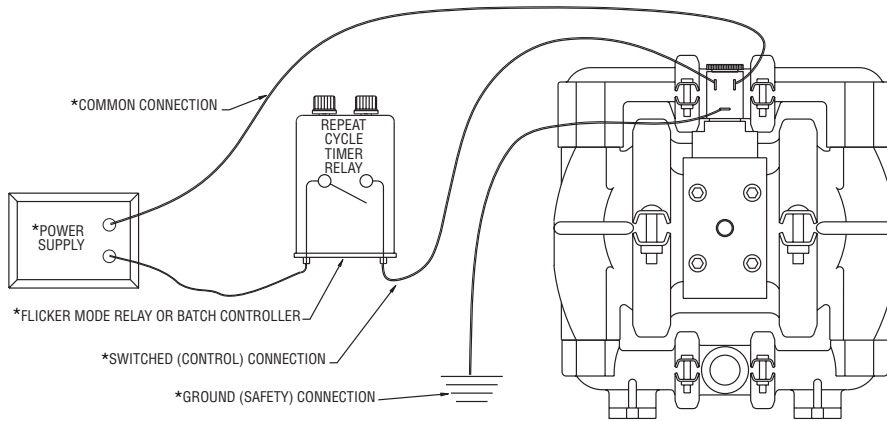

ACCU-FLO™ PLUMBING CONNECTIONS

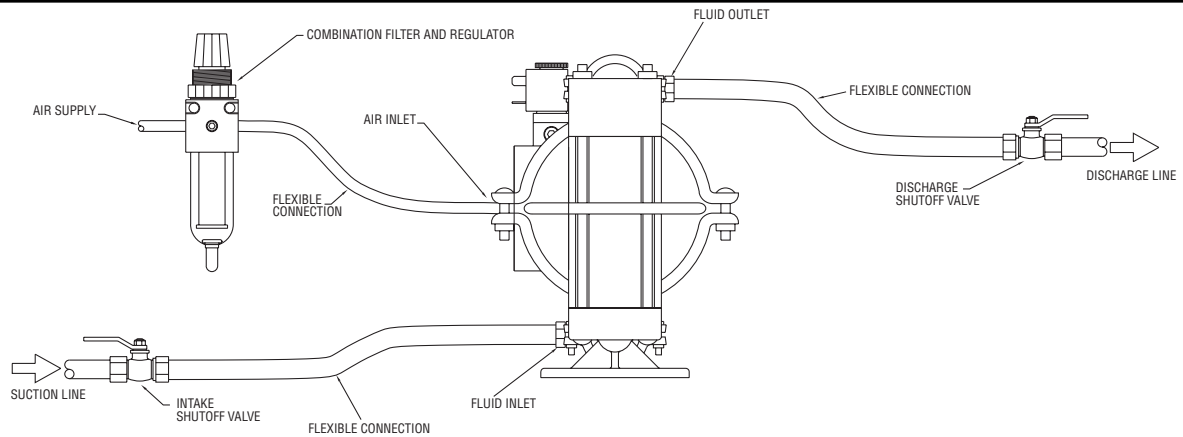

SECTION 7E – ACCU-FLO™

SUGGESTED OPERATION AND MAINTENANCE INSTRUCTIONS

OPERATION: The speed of the pump is controlled electrically. Since each stroke is controlled by an electrical signal, the pump is ideal for batching and other electrically controlled dispensing applications.

Although the speed of the pump is controlled electrically, the air pressure is important. Air pressure displaces the fluid, and if the pressure is insufficient to complete the physical stroke before an electronic impulse signals the pump to shift, the stroke will not be completed, and the displacement per stroke will be reduced. This does not harm the unit in any way, but it may cause inaccuracy when attempting to batch specific quantities with high precision.

The solenoid operated pump is permanently lubricated during assembly, and requires no additional lubrication under normal operation. If the unit runs under extreme conditions (continuous operation at high speeds), it may be necessary to relubricate the center block with a buna-N compatible NLGI Grade 2 grease every 50 million cycles. Continuous lubrication with a compatible oil is not harmful, and will provide longer seal life, but it may flush all grease out of the unit.

A red button on the side of the air valve is a manual override; when actuated it will shift the valve as if an electric current had actuated the solenoid.

RECORDS: When service is required, a record should be made of all necessary repairs and replacements. Over a period of time, such records can become a valuable tool for predicting and preventing future maintenance problems and unscheduled downtime. In addition, accurate records make it possible to identify pumps that are poorly suited to their applications.

MAINTENANCE AND INSPECTIONS: Since each application is unique, maintenance schedules may be different for every pump. Frequency of use, line pressure, viscosity and abrasiveness of process fluid all affect the parts life of a Wilden pump. Periodic inspections have been found to offer the best means for preventing unscheduled pump downtime. Personnel familiar with the pump's construction and service should be informed of any abnormalities that are detected during operation. Internal maintenance is not recommended for Accu-Flo™ solenoid air valves. When worn or damaged, a new air valve body, coil or terminal connector must be purchased. Please consult section 9C for part numbers.

SECTION 7F – AIR-CONTROLLED TROUBLESHOOTING

Pump will not run or runs slowly.

1. Check air inlet screen and air filter for debris.
2. Check for sticking air valve, flush air valve in solvent.
3. Check for worn out air valve. If piston face in air valve is shiny instead of dull, air valve is probably worn beyond working tolerances and must be replaced.
4. Check center block Glyd™ rings. If worn excessively, they will not seal and air will simply flow through pump and out air exhaust. Use only Wilden Glyd™ rings as they are of special construction.
5. Check for rotating piston in air valve.
6. Check type of lubricant being used. A higher viscosity oil than suggested may cause the piston to stick or run erratically. Wilden suggests the use of an oil with arctic characteristics (ISO 15-5 wt.).

Pump runs but little or no product flows.

1. Check for pump cavitation; slow pump speed down to match thickness of material being pumped.
2. Check for sticking ball check valves. If material being pumped is not compatible with pump elastomers,

swelling may occur. Replace ball check valves and o-rings with the proper elastomers.

3. Check to make sure all suction connections are air tight, especially clamp bands around intake balls.

Pump air valve freezes.

Check for excessive moisture in compressed air. Either install dryer or hot air generator for compressed air.

Air bubbles in pump discharge.

1. Check for ruptured diaphragm.
2. Check tightness of clamp bands, especially at intake manifold.

Product comes out air exhaust.

1. Check for diaphragm rupture.
2. Check tightness of piston plates to shaft.

Pump rattles.

1. Create false discharge head or suction lift.

SECTION 7G – ACCU-FLO™ TROUBLESHOOTING

Pump will not run.

1. Check for pressurized air at the inlet. (3.1 bar [Min. 45 psig].)
2. Check air inlet and filter for debris.
3. Connect a test lamp to the two wires which run to pump and ensure that the lamp cycles on and off.
4. Make sure that the air valve manual override (small red knob on front of valve) is switched to the "0" position.
5. Check pilot pressure vent at the top of the operator/coil assembly to ensure that it is not clogged.
6. Check for a worn out air valve. If air continually blows out the exhaust in very large quantities, the air valve seals may be worn beyond their ability to function. In this case, the valve must be replaced.
NOTE: Before the valve is scrapped, it is possible that it may be saved by completely disassembling the valve, cleaning all components and relubricating the valve.

Pump runs but little or no fluid comes out.

1. Check that the discharge isolation valve is not closed.
2. Check that the electronic signal is slow enough that the pump is able to complete each physical stroke before it is signaled to change direction. The time required to complete the stroke is determined by a variety of factors which include fluid viscosity and head pressure. The shaft can be viewed if the muffler is removed to verify that the pump is stroking.
3. Check for pump cavitation; slow pump speed down to match the thickness of the material being pumped.
4. Check for sticking ball check valves. If the material being pumped is not compatible with the pump elastomers, swelling may occur. Replace ball check valves and o-ring with the proper elastomers.
5. Check to make sure that all suction connections are air tight, and that the clamp bands are properly tightened.

Pump air passages blocked with ice.

Check for excessive moisture in compressed air line. As the air expands out the exhaust during the operation of the pump, water vapor entrapped in the compressed air can freeze and block the air passageways in the pump. If this occurs, it may be necessary to install a coalescing filter, an air dryer, or a hot air generator for the compressed air.

Air bubbles in pump discharge.

1. Check for ruptured diaphragm.
2. Check tightness of clamp bands, and the integrity of the o-rings, especially at intake manifold.

Product comes out air exhaust.

1. Check for diaphragm rupture.
2. Check tightness of piston plates to shaft.

Pump rattles.

1. Create false discharge head or suction lift.

Solenoid buzzes or solenoid burnout.

1. Incorrect voltage, faulty or dirty solenoid.

Solenoid valve fails to shift electrically but shifts with manual override.

1. Incorrect voltage, defective coil or wiring.

Solenoid valve fails to shift electrically or with manual override.

1. Inadequate air supply, contamination, inadequate or improper lubrication, mechanical binding in the valve.

Valve shifts but fails to return.

1. Broken spring, mechanical binding.

Excessive leaking from air valve vent.

1. Worn seals in air valve.

SECTION 8A

T8 PLASTIC

DIRECTIONS FOR DISASSEMBLY/REASSEMBLY

CAUTION: Before any maintenance or repair is attempted, the compressed air line to the pump should be disconnected and all air pressure allowed to bleed from the pump. Disconnect all intake, discharge, and air lines. Drain the pump by turning it upside down and allowing any fluid to flow into a suitable container. Be aware of any hazardous effects of contact with your process fluid.

The Wilden model T8 plastic has a 51 mm (2") inlet and outlet and is designed for flows up to 591 lpm (156 gpm). The model T8 plastic is available in polypropylene wetted parts. The air valve is manufactured of brass, PTFE-coated brass, nickel-plated brass or Stainless Steel. All o-rings used in the pump are of a special material and shore hardness which should only be replaced with factory-supplied parts.

TOOLS REQUIRED:

13 mm (1/2") Wrench

17 mm (11/16") Socket Wrench

Adjustable Wrench

Vise equipped with soft jaws (such as plywood, plastic or other suitable material)

NOTE: The model used for these instructions incorporates rubber diaphragms, balls, and seats. Models with PTFE diaphragms, balls and seats are the same except where noted. The procedures for the A8 Accu-Flo™ pump are the same except for the air distribution system.

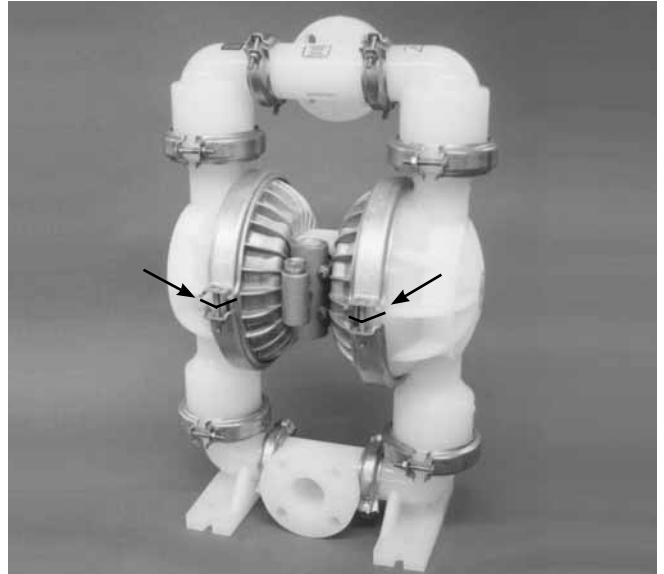

DISASSEMBLY:

Figure 1

Step 1.

Before starting disassembly, mark a line from each liquid chamber to its corresponding air chamber. This line will assist in proper alignment during reassembly.



Step 2.

Figure 2

Utilizing a 13 mm (1/2") wrench, remove the two small clamp bands that fasten the discharge manifold to the liquid chambers.



Step 3.

Figure 3

Lift away the discharge manifold to expose the valve ball guide bushings and seats.



Step 4. *Figure 4*

Remove the discharge valve balls, seats from atop the liquid chambers and inspect for nicks, gouges, chemical attack or abrasive wear. Replace worn parts with genuine Wilden parts for reliable performance.



Step 5. *Figure 5*

Remove the two small clamp bands, which fasten the intake manifold to the liquid chambers, and lift away the intake manifold to expose intake valve balls and seats.

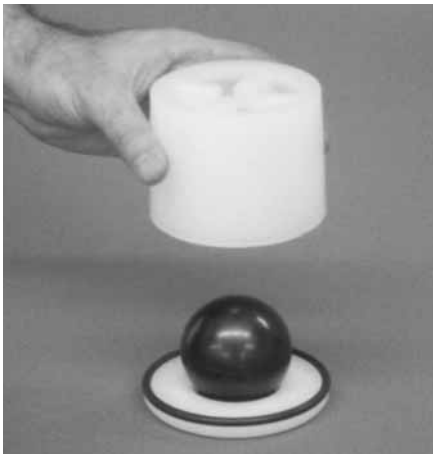

Step 6. *Figure 6*

Inspect ball guide bushing, ball, seat and o-ring for nicks, gouges, chemical attack or abrasive wear. Replace worn parts with genuine Wilden parts for reliable performance.

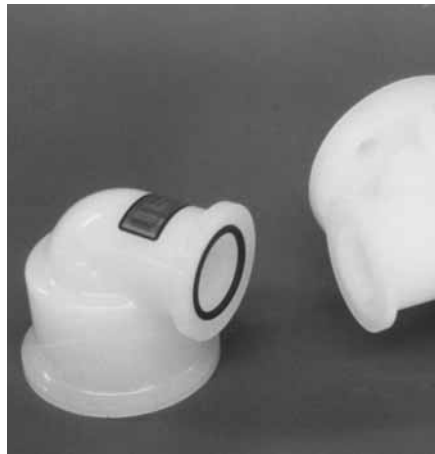

Step 7. *Figure 7*

If necessary remove small manifold clamp bands to inspect manifold o-rings.



Step 8. *Figure 8*

Remove one set of large clamp bands, which secure one liquid chamber to the center section.



Step 9. *Figure 9*
Lift liquid chamber away from center section expose diaphragm and outer piston.



Step 10. *Figure 10*
Using an adjustable wrench, or by rotating the diaphragm by hand, remove the diaphragm assembly.



Step 11A. *Figure 11A*

NOTE: Due to varying torque values, one of the following two situations may occur: 1) The outer piston, diaphragm and inner piston remain attached to the shaft and the entire assembly can be removed from the center section.



Step 11B. *Figure 11B*

2) The outer piston, diaphragm and inner piston separate from the shaft which remains connected to the opposite side diaphragm assembly. Repeat disassembly instructions for the opposite liquid chamber. Inspect diaphragm assembly and shaft for signs of wear or chemical attack. Replace all worn parts with genuine Wilden parts for reliable performance.



Step 12. *Figure 12*

To remove the diaphragm assembly from the shaft, secure shaft with soft jaws (a vise fitted with plywood or other suitable material) to ensure shaft is not nicked, scratched, or gouged. Using an adjustable wrench, remove diaphragm assembly from shaft. Inspect all parts for wear and replace with genuine Wilden parts if necessary.

SECTION 8B

AIR VALVE / CENTER BLOCK DISASSEMBLY

The air valve assembly consists of both the air valve body and piston and the center block. The unique design of the air valve relies only on differential pressure to effect the diaphragm shift. It is reliable and simple to maintain. The bushing in the center block, along with the diaphragm shaft, provides the "trigger" to tell the air valve to shift. The following procedure will ensure that the air valve on your Wilden pump will provide long trouble-free service.

AIR VALVE BODY AND PISTON ASSEMBLY AND DISASSEMBLY:

The air valve body and piston can be disconnected from the pump by removing the four socket head cap screws which attach it to the center block. The piston in the air valve is aluminum with a dark gray anodized coating. The piston should move freely and the ports in the piston should line up with the ports on the face of the air valve body (see below). The piston should also appear to be a dull, dark gray in color. If the piston appears to be a shiny aluminum color, the air valve is probably worn beyond working tolerance and should be replaced.

If the piston does not move freely in the air valve, the entire air valve should be immersed in a cleaning solution.

[NOTE: Do not force the piston by inserting a metal object.] This soaking should remove any accumulation of sludge and grit which is preventing the air valve piston from moving freely. Also, remove and clean the air valve screen. If the air valve piston does not move freely after the above cleaning, the air valve should be disassembled as follows: remove the snap ring from the top end of the air valve cylinder and apply an air jet to the 3/16-inch hole on the opposite end of the air valve face. (See *Figure C*.) **CAUTION:** The air valve end cap may come out with considerable force. Hand protection such as a padded glove or rag should be used to capture the end cap.

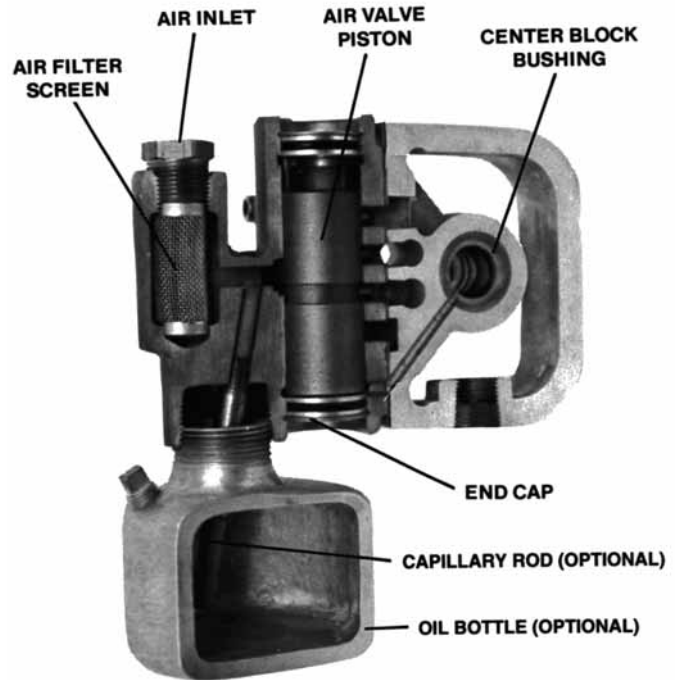

NOTE: Air valve available with or without oil bottle and capillary rod.



Figure C

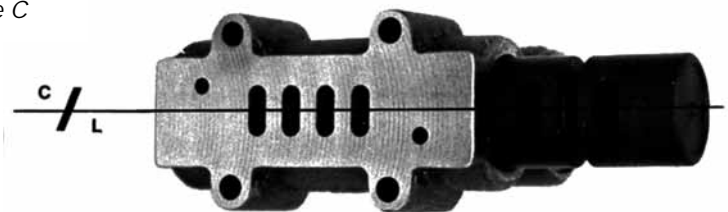

Figure D

Small nicks can usually be dressed out and the piston returned to service. Make sure that the guide pin is straight and smooth or the piston will not move freely in the cylinder. Clean out anti-centering pin holes located at each side of the piston. Pin holes are located on each side of the annular groove on the top of the piston and travel to each end. New o-rings should be installed on the end caps. Lubricate the o-rings and install the end caps, assuring that proper alignment of the piston and cylinder ports is maintained. (See *Figure D*). Reinstall air valve to center block of pump. Tighten per the torque specifications in Section 8D (page 21).

GLYD™ RING REPLACEMENT:

When the Glyd™ rings become worn, they will no longer seal and must be replaced. Due to the design characteristics of the Glyd™ rings, it is suggested that you use the Ringer Seal installation kit when replacing Glyd™ rings. Consult EOM-Ringer for installation instructions.

CENTER BLOCK ASSEMBLY:

The pump's center block consists of a polypropylene or die cast housing with a cast-in bronze bushing. The bushing has eleven grooves cut on the inside diameter. There are seven Glyd™ rings that fit in these grooves (see *Figure E*). Since these Glyd™ rings form a part of the shifting function of the pump, it is necessary that they be located in the proper grooves. The bronze bushing is replaceable in cast iron or stainless steel center blocks only. When bushing wear becomes excessive, a new center block must be used.

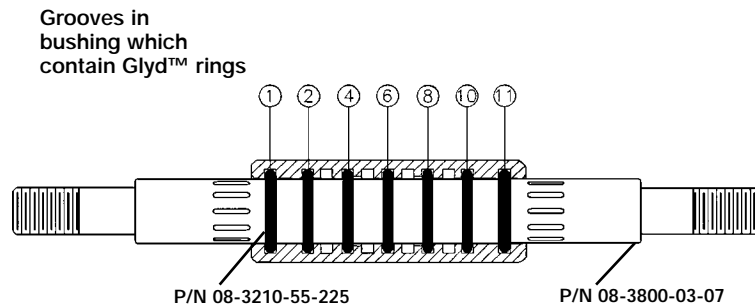
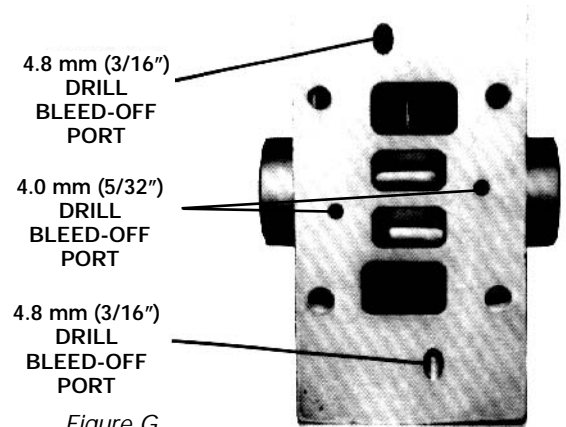

Figure E



Figure F (Side View)

P/N 08-3300-07 Bronze Bushing can be pressed into a stainless steel or cast iron center section. (See *Figure F*). When installing a new bushing, four bleeder holes which allow the pump to exhaust air must be drilled. (See *Figure G*).



*Figure G
Center Block
(Front View)*

SECTION 8C

REASSEMBLY HINTS & TIPS

ASSEMBLY:

Upon performing applicable maintenance to the air distribution system, the pump can now be reassembled. Please refer to the disassembly instructions for photos and parts placement. To reassemble the pump, follow the disassembly instructions in reverse order. The air distribution system needs to be assembled first, then the diaphragms and finally the wetted path. Please find the applicable torque specifications on this page. The following tips will assist in the assembly process.

- Clean the inside of the center section shaft bushing to ensure no damage is done to new seals.
- Stainless bolts should be lubed to reduce the possibility of seizing during tightening.

- Ensure proper alignment on the sealing surfaces of intake and discharge manifolds.
- Liquid chambers are easier to attach when the diaphragm is inverted. Prior to attaching the second water chamber, push diaphragm assembly so that it is as close as possible to the center section.
- PVDF and PFA pumps require PTFE gasket kits for improved sealing. Gasket kits may be installed on other pumps where sealing is an issue.
- When assembling PTFE-coated hardware, care should be taken to keep the coating intact.
- When installing Glyd™ rings, the use of the Wilden Ringer tool simplifies seal installation.

MAXIMUM TORQUE SPECIFICATIONS

Description of Part	Plastic Pumps
Air Valve	6.8 N•m (60 in-lbs)
Outer Piston (PTFE-fitted)	81.3 N•m (58 ft-lbs)
Outer Piston (Rubber-fitted)	81.3 N•m (58 ft-lbs)
Small Clamp Band (All)	6.2 N•m (55 in-lbs)
Medium Clamp Band	10.2 N•m (90 in-lbs)
Large Clamp Band (All)	40.0 N•m (28 ft-lbs)
Center Block Assembly	47.5 N•m (35 ft-lbs)

SECTION 8D

GASKET KIT INSTALLATION

Only PTFE-fitted T8 PVDF and polypropylene pumps come standard with expanded PTFE Gasket Kits (P/N 08-9503-99 for PVDF and 08-9502-99 for polypropylene). Carefully prepare sealing surfaces by removing all debris and foreign

matter from diaphragm bead and all mating surfaces. If necessary, smooth or deburr all sealing surfaces. Mating surfaces must be properly aligned in order to ensure positive sealing characteristics.

PVDF AND POLYPROPYLENE

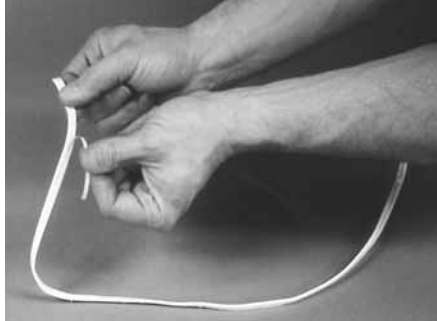

Step 1. *Figure 1*
Gently remove the adhesive covering from the back of the PTFE tape. Ensure that the adhesive strip remains attached to the PTFE tape.



Step 2. *Figure 2*
Starting at any point, place the PTFE tape in the center of the diaphragm bead groove on the liquid chamber and press lightly on the tape to ensure that the adhesive holds it in place during assembly. Do not stretch the tape during placement in center of diaphragm bead groove.



Step 3. *Figure 3*
The ends of the tape should overlap approximately 13 mm (1/2"). Proceed to install the PTFE tape on the remaining liquid chamber.

PVDF



Step 4. *Figure 4*
Carefully remove the protective covering from the back of the PTFE gasket attached to tape.



Step 5. *Figure 5*
Install the valve ball, valve seat and o-ring.



Step 6. *Figure 6*
Center the gasket so that it evenly covers the o-ring and seat areas.



Step 7. *Figure 7*
Gently apply pressure to gasket to ensure the adhesive maintains a positive seal to stay in place during pump assembly.

SECTION 9A

EXPLODED VIEW/PARTS LISTING

T8
PLASTIC
AIR-
CONTROLLED

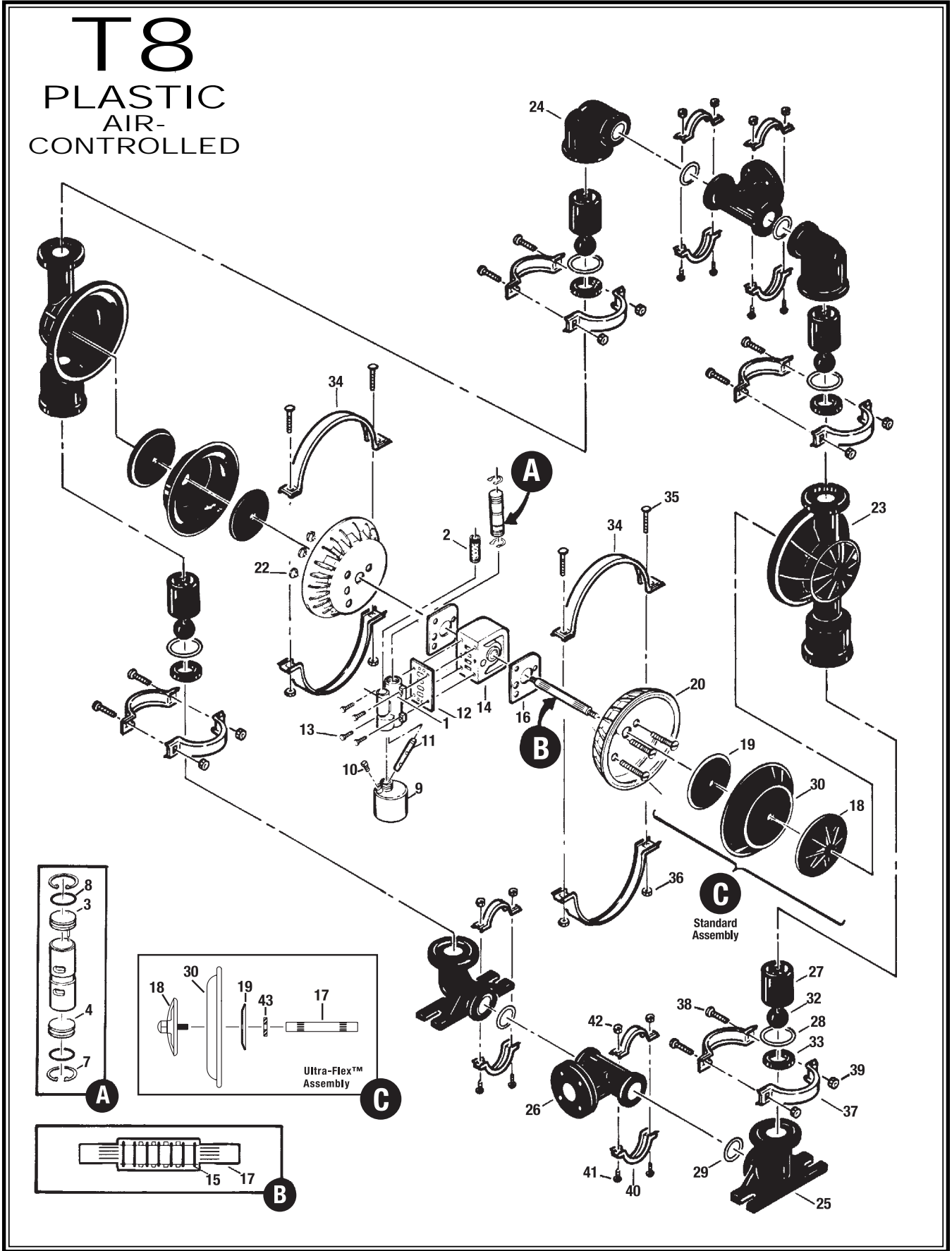

T8 PLASTIC RUBBER/TPE-FITTED

Item	Part Description	Qty.	T8/PKAPB P/N	T8/PKSSB P/N	T8/PKWPB P/N	T8/PKCPC/0502 P/N
1	Air Valve Assembly¹	1	08-2000-07	08-2000-07	08-2000-07	08-2000-05
2	Air Valve Screen	1	08-2500-07	08-2500-07	08-2500-07	08-2500-07
3	Air Valve End Cap w/Guide (Top)	1	08-2300-23	08-2300-23	08-2300-23	08-2300-23
4	Air Valve End Cap w/o Guide (Bottom)	1	08-2330-23	08-2330-23	08-2330-23	08-2330-23
5	End Cap Cover (Not shown)	2	N/R	N/R	N/R	08-2420-55
6	End Cap Bolt (Not shown)	2	N/R	N/R	N/R	08-2450-22
7	Air Valve Snap Ring	2	08-2650-03	08-2650-03	08-2650-03	08-2650-03
8	Air Valve Cap O-Ring	2	08-2390-52	08-2390-52	08-2390-52	08-2390-52
9	Oil Bottle (Optional)	1	08-2850-01	08-2850-01	08-2850-01	N/A
10	Plug (Optional)	1	08-7000-07	08-7000-07	08-7000-07	N/A
11	Capillary Rod (Optional)	1	08-2900-99	08-2900-99	08-2900-99	N/A
12	Air Valve Gasket — Buna-N	1	08-2600-52	08-2600-52	08-2600-52	08-2600-52
13	Air Valve Screw	4	08-6000-03	08-6000-03	08-6000-03	08-6000-05
14	Center Block	1	08-3100-20-225	08-3100-20-225	08-3100-20-225	08-3100-20-225
15	Center Block Glyd™ Ring	7	08-3210-55-225	08-3210-55-225	08-3210-55-225	08-3210-55-225
16	Block Gasket — Buna-N	2	08-3520-52	08-3520-52	08-3520-52	08-3520-52
17	Shaft	1	08-3800-09-07	08-3800-09-07	08-3800-09-07	08-3800-09-07
	Shaft, Ultra-Flex™	1	08-3820-03-07	08-3820-03-07	08-3820-03-07	08-3820-03-07
18	Piston, Outer	2	08-4550-21-500	08-4550-21-500	08-4550-21-500	08-4550-21-500
	Piston, Outer, Ultra-Flex™	2	08-4560-21	08-4560-21	08-4560-21	08-4560-21
29	Piston, Inner	2	08-3700-01	08-3700-01	08-3700-01	08-3700-01
	Piston, Inner, Ultra-Flex™	2	04-3700-08	04-3700-08	04-3700-08	04-3700-08
20	Air Chamber, Counter Sunk	2	08-3650-01	08-3650-03	08-3650-02	08-3650-05
21	Air Chamber Screw - 3/8" -16 x 3-9/16"	3	08-6200-08	08-6200-03	08-6200-08	08-6200-03
22	Air Chamber Cone Nut 3/8" -16	3	08-6550-08	08-6550-03	08-6550-08	08-6550-03
23	Liquid Chamber	2	08-5000-20	08-5000-20	08-5000-20	08-5000-20
24	Discharge Elbow	2	08-5230-20	08-5230-20	08-5230-20	08-5230-20
25	Inlet Elbow	2	08-5220-20	08-5220-20	08-5220-20	08-5220-20
26	Manifold T-Section	2	08-5160-20	08-5160-20	08-5160-20	08-5160-20
27	Ball Guide Bushing	4	08-5350-20-500	08-5350-20-500	08-5350-20-500	08-5350-20-500
28	Valve Seat O-Ring*	4	*	*	*	*
29	Manifold O-Ring*	4	*	*	*	*
30	Diaphragm*	2	*	*	*	*
31	Diaphragm, Backup	2	N/A	N/A	N/A	N/A
32	Valve Ball*	4	*	*	*	*
33	Valve Seat	4	08-1120-20-500	08-1120-20-500	08-1120-20-500	08-1120-20-500
34	Large Clamp Band, Assy.	2	08-7300-03-500	08-7300-03-500	08-7300-03-500	08-7300-05-500
35	Large Carriage Bolt 3/8" -16 x 2-1/2"	4	08-6070-03-500	08-6070-03-500	08-6070-03-500	08-6070-05-500
36	Large Hex Nut 3/8" -16	4	08-6450-03	08-6450-03	08-6450-03	08-6420-05
37	Medium Clamp Band, Assy.	4	08-7200-03-500	08-7200-03-500	08-7200-03-500	08-7200-05-500
38	Medium Carriage Bolt 5/16" -18 x 2-1/4"	8	04-6070-03	04-6070-03	04-6070-03	04-6070-05
39	Medium Hex Nut 5/16" -18	8	08-6400-03	08-6400-03	08-6400-03	08-6400-05
40	Small Clamp Band, Assy.	4	08-7100-03-500	08-7100-03-500	08-7100-03-500	08-7100-05-500
41	Small Carriage Bolt 5/16" -18 x 2"	8	08-6050-03-500	08-6050-03-500	08-6050-03-500	08-6050-05-500
42	Small Square Nut	8	08-6400-03	08-6400-03	08-6400-03	08-6400-05
43	Spacer, Ultra-Flex™	1	08-3860-08	08-3860-08	08-3860-08	08-3860-08
	Muffler (Optional — not shown)	1	08-3510-99	08-3510-99	08-3510-99	08-3510-99

¹Air Valve Assembly includes parts through 08-2390-52 (items 2 through 7). To order pump with oil bottle, add letter D to model #. (Example: T8/AAPD.)

*Refer to corresponding elastomer chart in Section 10.

0502 Specialty Code = PTFE-Coated Hardware

All boldface items are primary wear parts.

SECTION 9B

EXPLODED VIEW/PARTS LISTING

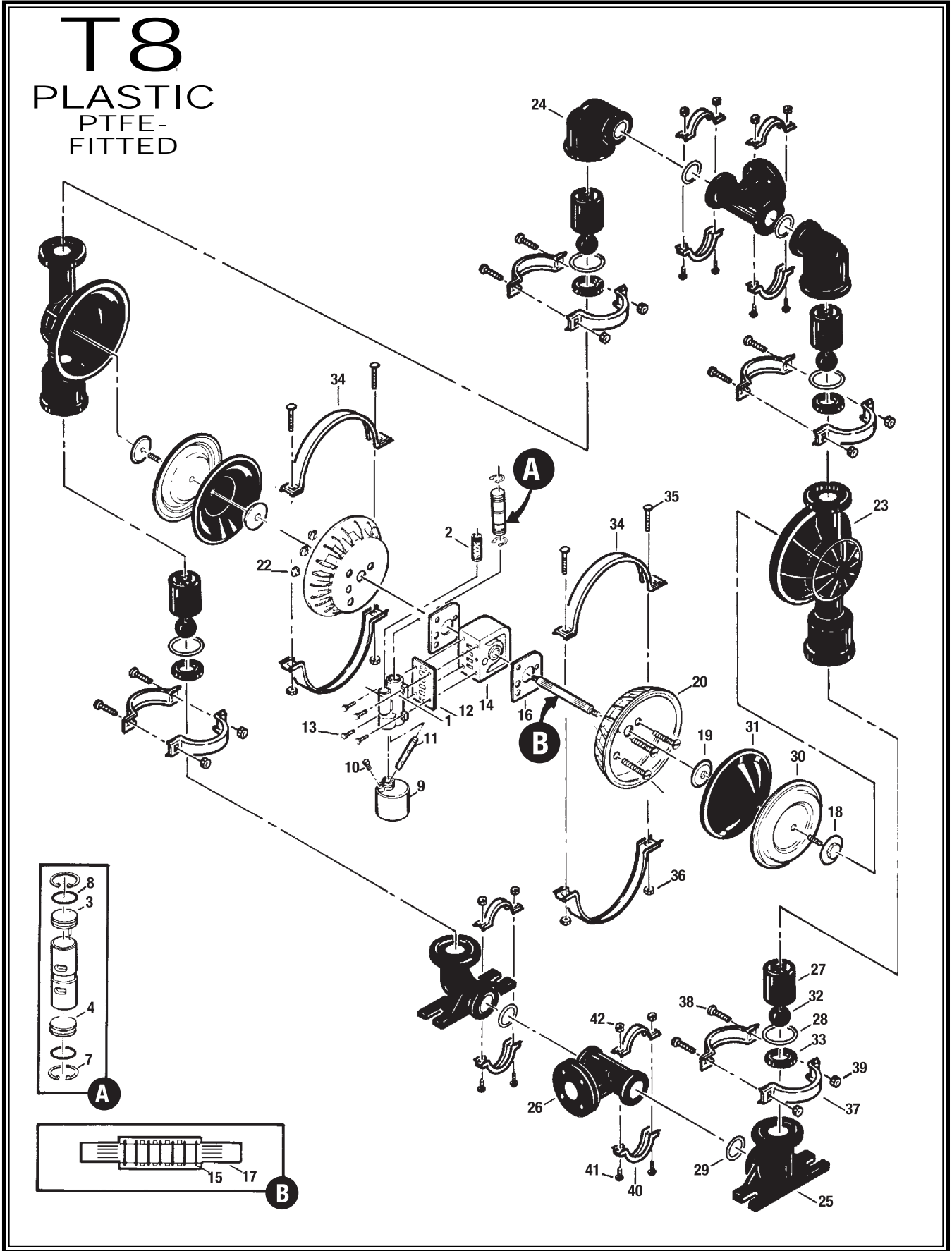

T8 PLASTIC PTFE-FITTED

Item	Part Description	Qty.	T8/PKAPB/ TF/TF/PTV P/N	T8/PKSSB/ TF/TF/PTV P/N	T8/PKWPB/ TF/TF/PTV P/N	T8/PKCPC/ TF/TF/PTV/0502 P/N
1	Air Valve Assembly¹	1	08-2000-07	08-2000-07	08-2000-07	08-2000-05
2	Air Valve Screen	1	08-2500-07	08-2500-07	08-2500-07	08-2500-07
3	Air Valve End Cap w/Guide (Top)	1	08-2300-23	08-2300-23	08-2300-23	08-2300-23
4	Air Valve End Cap w/o Guide (Bottom)	1	08-2330-23	08-2330-23	08-2330-23	08-2330-23
5	End Cap Cover (Not shown)	2	N/R	N/R	N/R	08-2420-55
6	End Cap Bolt (Not shown)	2	N/R	N/R	N/R	08-2450-22
7	Air Valve Snap Ring	2	08-2650-03	08-2650-03	08-2650-03	08-2650-03
8	Air Valve Cap O-Ring	2	08-2390-52	08-2390-52	08-2390-52	08-2390-52
9	Oil Bottle (Optional)	1	08-2850-01	08-2850-01	08-2850-01	N/A
10	Plug (Optional)	1	08-7000-07	08-7000-07	08-7000-07	N/A
11	Capillary Rod (Optional)	1	08-2900-99	08-2900-99	08-2900-99	N/A
12	Air Valve Gasket — Buna-N	1	08-2600-52	08-2600-52	08-2600-52	08-2600-52
13	Air Valve Screw	4	08-6000-03	08-6000-03	08-6000-03	08-6000-05
14	Center Block	1	08-3100-20-225	08-3100-20-225	08-3100-20-225	08-3100-20-225
15	Center Block Glyd™ Ring	7	08-3210-55-225	08-3210-55-225	08-3210-55-225	08-3210-55-225
16	Block Gasket — Buna-N	2	08-3520-52	08-3520-52	08-3520-52	08-3520-52
17	Shaft	1	08-3820-03-07	08-3820-03-07	08-3820-03-07	08-3820-03-07
18	Piston, Outer	2	08-4600-21-500	08-4600-21-500	08-4600-21-500	08-4600-21-500
19	Piston, Inner	2	08-3750-01	08-3750-03	08-3750-01	08-3750-01
20	Air Chamber, Counter Sunk	2	08-3650-01	08-3650-03	08-3650-02	08-3650-05
21	Air Chamber Screw - 3/8"-16 x 3-9/16"	3	08-6200-08	08-6200-03	08-6200-08	08-6200-03
22	Air Chamber Cone Nut 3/8"-16	3	08-6550-08	08-6550-03	08-6550-08	08-6550-03
23	Liquid Chamber	2	08-5000-20	08-5000-20	08-5000-20	08-5000-20
24	Discharge Elbow	2	08-5230-20	08-5230-20	08-5230-20	08-5230-20
25	Inlet Elbow	2	08-5220-20	08-5220-20	08-5220-20	08-5220-20
26	Manifold T-Section	2	08-5160-20	08-5160-20	08-5160-20	08-5160-20
27	Ball Guide Bushing	4	08-5350-20-500	08-5350-20-500	08-5350-20-500	08-5350-20-500
28	Valve Seat O-Ring	4	08-1200-60-500	08-1200-60-500	08-1200-60-500	08-1200-60-500
29	Manifold O-Ring	4	08-1300-60-500	08-1300-60-500	08-1300-60-500	08-1300-60-500
30	Diaphragm	2	08-1010-55	08-1010-55	08-1010-55	08-1010-55
31	Diaphragm, Backup²	2	08-1060-51	08-1060-51	08-1060-51	08-1060-51
32	Valve Ball	4	08-1080-55	08-1080-55	08-1080-55	08-1080-55
33	Valve Seat	4	08-1120-20-500	08-1120-20-500	08-1120-20-500	08-1120-20-500
34	Large Clamp Band, Assy.	2	08-7300-03-500	08-7300-03-500	08-7300-03-500	08-7300-05-500
35	Large Carriage Bolt 3/8"-16 x 2-1/2"	4	08-6070-03-500	08-6070-03-500	08-6070-03-500	08-6070-05-500
36	Large Hex Nut 3/8"-16	4	08-6450-03	08-6450-03	08-6450-03	08-6420-05
37	Medium Clamp Band, Assy.	4	08-7200-03-500	08-7200-03-500	08-7200-03-500	08-7200-05-500
38	Medium Carriage Bolt 5/16"-18 x 2-1/4"	8	04-6070-03	04-6070-03	04-6070-03	04-6070-05
49	Medium Hex Nut 5/16"-18	8	08-6400-03	08-6400-03	08-6400-03	08-6400-05
40	Small Clamp Band, Assy.	4	08-7100-03-500	08-7100-03-500	08-7100-03-500	08-7100-05-500
41	Small Hex Head Cap Screw 5/16"-18 x 2"	8	08-6050-03-500	08-6050-03-500	08-6050-03-500	08-6050-05-500
42	Small Square Nut	8	08-6400-03	08-6400-03	08-6400-03	08-6400-05
	Muffler (Optional — not shown)	1	08-3510-99	08-3510-99	08-3510-99	08-3510-99

¹Air Valve Assembly includes parts through 08-2390-52 (items 2 through 7). To order pump with oil bottle, add letter D to model #. (Example: T8/AAPD.)

²PTFE diaphragm, P/N 08-1010-55, must be used with Neoprene back-up diaphragms, P/N 08-1060-51.

0502 Specialty Code = PTFE-Coated Hardware

All boldface items are primary wear parts.

SECTION 9C

EXPLODED VIEW/PARTS LISTING

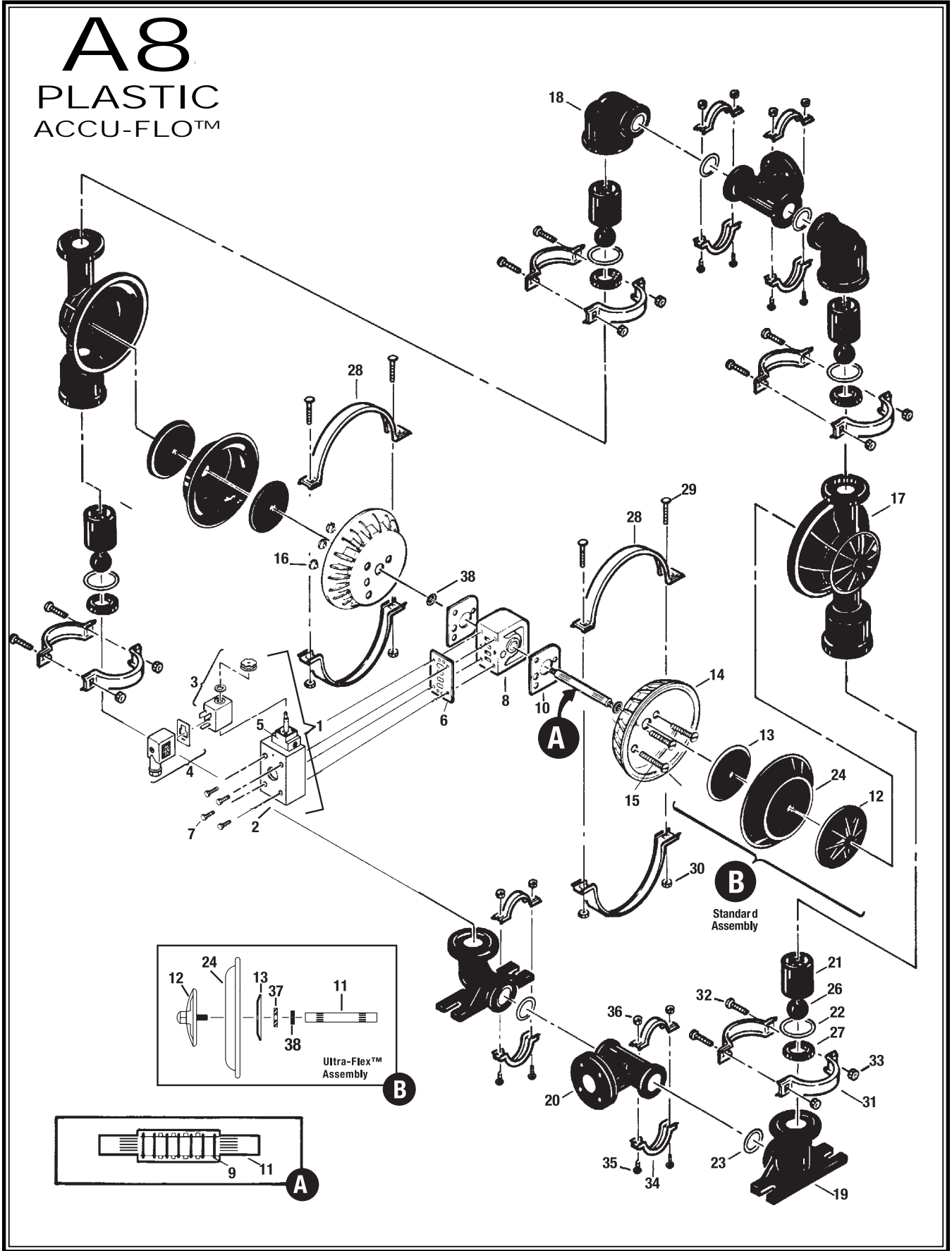

A8 PLASTIC ACCU-FLO™

Item	Part Description	Qty.	Rubber-Fitted				PTFE-Fitted			
			A8/ PKAPA/0150 P/N	A8/ PKSSA/0150 P/N	A8/ KKAPA/0150 P/N	A8/ KKSSA/0150 P/N	A8/PKAPA/ TF/TF/PTS/0150 P/N	A8/PKSSA/ TF/TF/PTS/0150 P/N	A8/KKAPA/ TF/TF/KTV/0150 P/N	A8/KKSSA/ TF/TF/KTV/0150 P/N
1	Solenoid Valve Assembly ¹	1	08-2000-99-150	08-2000-99-150	08-2000-99-150	08-2000-99-150	08-2000-99-150	08-2000-99-150	08-2000-99-150	08-2000-99-150
2	Main Valve Body	1	08-2000-01-150	08-2000-01-150	08-2000-01-150	08-2000-01-150	08-2000-01-150	08-2000-01-150	08-2000-01-150	08-2000-01-150
3	Coil	1	00-2110-99-150	00-2110-99-150	00-2110-99-150	00-2110-99-150	00-2110-99-150	00-2110-99-150	00-2110-99-150	00-2110-99-150
4	Terminal Connector	1	00-2130-99	00-2130-99	00-2130-99	00-2130-99	00-2130-99	00-2130-99	00-2130-99	00-2130-99
5	Operator	1	00-2120-99	00-2120-99	00-2120-99	00-2120-99	00-2120-99	00-2120-99	00-2120-99	00-2120-99
6	Air Valve Gasket — Buna-N	1	08-2600-52	08-2600-52	08-2600-52	08-2600-52	08-2600-52	08-2600-52	08-2600-52	08-2600-52
7	Air Valve Screw	4	08-6000-03	08-6000-03	08-6000-03	08-6000-03	08-6000-03	08-6000-03	08-6000-03	08-6000-03
8	Center Block	1	08-3100-20-225	08-3100-03-225	08-3100-20-225	08-3100-03-225	08-3100-20-225	08-3100-03-225	08-3100-20-225	08-3100-03-225
9	Center Block Glyd™ Ring	7	08-3210-55-225	08-3210-55-225	08-3210-55-225	08-3210-55-225	08-3210-55-225	08-3210-55-225	08-3210-55-225	08-3210-55-225
10	Block Gasket — Buna-N	2	08-3520-52	08-3520-52	08-3520-52	08-3520-52	08-3520-52	08-3520-52	08-3520-52	08-3520-52
11	Shaft, Rubber/TPE	1	08-3805-09	08-3805-09	08-3805-09	08-3805-09	N/A	N/A	N/A	N/A
	Shaft, Ultra-Flex™/PTFE	1	08-3840-09	08-3840-09	08-3840-09	08-3840-09	08-3840-09	08-3840-09	08-3840-09	08-3840-09
12	Piston, Outer	2	08-4550-21-500	08-4550-21-500	08-4550-21-500	08-4550-21-500	08-4600-21-500	08-4600-21-500	08-4600-21-500	08-4600-21-500
	Piston, Outer, Ultra-Flex™	2	08-4560-21	08-4560-21	08-4560-21	08-4560-21	N/A	N/A	N/A	N/A
13	Piston, Inner	2	08-3700-01	08-3700-03	08-3700-01	08-3700-03	08-3750-01	08-3750-03	08-3750-01	08-3750-03
	Piston, Inner, Ultra-Flex™	2	04-3700-08	04-3700-08	04-3700-08	04-3700-08	N/A	N/A	N/A	N/A
14	Air Chamber, Counter Sunk	2	08-3650-01	08-3650-03	08-3650-01	08-3650-03	08-3650-01	08-3650-03	08-3650-01	08-3650-03
15	Air Chamber Screw - 3/8"-16 x 3-9/16"	3	08-6200-08	08-6200-03	08-6200-08	08-6200-03	08-6200-08	08-6200-03	08-6200-08	08-6200-03
16	Air Chamber Cone Nut 3/8"-16	3	08-6550-08	08-6550-03	08-6550-08	08-6550-03	08-6550-08	08-6550-03	08-6550-08	08-6550-03
17	Liquid Chamber	2	08-5000-20	08-5000-20	08-5000-21	08-5000-21	08-5000-20	08-5000-20	08-5000-21	08-5000-21
18	Discharge Elbow	2	08-5230-20	08-5230-20	08-5230-21	08-5230-21	08-5230-20	08-5230-20	08-5230-21	08-5230-21
19	Inlet Elbow	2	08-5220-20	08-5220-20	08-5220-21	08-5220-21	08-5220-20	08-5220-20	08-5220-21	08-5220-21
20	Manifold T-Section	2	08-5160-20	08-5160-20	08-5160-21	08-5160-21	08-5160-20	08-5160-20	08-5160-21	08-5160-21
21	Ball Guide Bushing	4	08-5350-20-500	08-5350-20-500	08-5350-21-500	08-5350-21-500	08-5350-20-500	08-5350-20-500	08-5350-21-500	08-5350-21-500
22	Valve Seat O-Ring*	4	*	*	*	*	08-1200-59-500	08-1200-59-500	08-1200-60-500	08-1200-60-500
23	Manifold O-Ring*	4	*	*	*	*	08-1300-59-500	08-1300-59-500	08-1300-60-500	08-1300-60-500
24	Diaphragm*	2	*	*	*	*	08-1010-55	08-1010-55	08-1010-55	08-1010-55
25	Diaphragm, Backup	2	N/A	N/A	N/A	N/A	08-1060-51	08-1060-51	08-1060-51	08-1060-51
26	Valve Ball*	4	*	*	*	*	08-1080-55	08-1080-55	08-1080-55	08-1080-55
27	Valve Seat	4	08-1120-20-500	08-1120-20-500	08-1120-21-500	08-1120-21-500	08-1120-20-500	08-1120-20-500	08-1120-21-500	08-1120-21-500
28	Large Clamp Band	2	08-7300-03-500	08-7300-03-500	08-7300-03-500	08-7300-03-500	08-7300-03-500	08-7300-03-500	08-7300-03-500	08-7300-03-500
29	Large Carriage Bolt 3/8"-16 x 2-1/2"	4	08-6070-03-500	08-6070-03-500	08-6070-03-500	08-6070-03-500	08-6070-03-500	08-6070-03-500	08-6070-03-500	08-6070-03-500
30	Large Hex Nut 3/8"-16	4	08-6450-03	08-6450-03	08-6450-03	08-6420-03	08-6450-03	08-6450-03	08-6450-03	08-6450-03
31	Medium Clamp Band	4	08-7200-03-500	08-7200-03-500	08-7200-03-500	08-7200-03-500	08-7200-03-500	08-7200-03-500	08-7200-03-500	08-7200-03-500
32	Medium Carriage Bolt 5/16"-18 x 2-1/4"	8	04-6070-03	04-6070-03	04-6070-03	04-6070-03	04-6070-03	04-6070-03	04-6070-03	04-6070-03
33	Medium Hex Nut 5/16"-18	8	08-6400-03	08-6400-03	08-6400-03	08-6400-03	08-6400-03	08-6400-03	08-6400-03	08-6400-03
34	Small Clamp Band	4	08-7100-03-500	08-7100-03-500	08-7100-03-500	08-7100-03-500	08-7100-03-500	08-7100-03-500	08-7100-03-500	08-7100-03-500
35	Small Hex Head Cap Screw 5/16"-18 x 1-3/4"	8	08-6050-03-500	08-6050-03-500	08-6050-03-500	08-6050-03-500	08-6050-03-500	08-6050-03-500	08-6050-03-500	08-6050-03-500
36	Small Square Nut	8	08-6400-03	08-6400-03	08-6400-03	08-6400-03	08-6400-03	08-6400-03	08-6400-03	08-6400-03
	Muffler (Optional — not shown)	1	08-3510-99	08-3510-99	08-3510-99	08-3510-99	08-3510-99	08-3510-99	08-3510-99	08-3510-99
37	Spacer, Ultra-Flex™	1	08-3860-08	08-3860-08	08-3860-08	08-3860-08	08-3860-08	08-3860-08	08-3860-08	08-3860-08
38	Bumper Pad	2	08-6900-23-50	08-6900-23-50	08-6900-23-50	08-6900-23-50	08-3860-08	08-3860-08	08-6900-23-50	08-6900-23-50

¹Solenoid Assembly includes items 2, 3, and 4.

NOTE: Additional solenoid options are available. Please consult Section 10B for electrical reference.

0150 Specialty Code = Solenoid-operated, 24V DC.

* Refer to corresponding elastomer chart in Section 10.

All boldface items are primary wear parts.

SECTION 10A

ELASTOMER OPTIONS

T8 PLASTIC

MATERIAL	TRADITIONAL DIAPHRAGMS (2)	ULTRA-FLEX™ DIAPHRAGMS (2)	VALVE SEAT O-RINGS (4)	MANIFOLD O-RINGS (4)	VALVE BALL (4)
Polyurethane	08-1010-50	N/A	08-1200-50-500	08-1300-50-500	08-1080-50
Neoprene	08-1010-51	08-1020-51	N/A	N/A	08-1080-51
Buna-N	08-1010-52	08-1020-52	08-1200-52-500	08-1300-52-500	08-1080-52
EPDM	08-1010-54	08-1020-54	N/A	N/A	08-1080-54
Viton®	08-1010-53	08-1020-53	N/A	N/A	08-1080-53
Saniflex™	08-1010-56	N/A	N/A	N/A	08-1080-56
PTFE	08-1010-551	N/A	N/A	N/A	08-1080-55
Tetra-Flex™ PTFE, Neoprene Backed	08-1010-64	N/A	N/A	N/A	N/A
Tetra-Flex™ PTFE, EPDM Backed	08-1010-81	N/A	N/A	N/A	N/A
Neoprene Backup	08-1060-51	N/A	N/A	N/A	N/A
Wil-Flex™	08-1010-58	N/A	N/A	N/A	08-1080-58
PTFE Encap. (Viton®)	N/A	N/A	08-1200-60-500	08-1300-60-500	N/A

NOTES

PTFE-encapsulated Viton® o-rings, P/N 08-1200-60-500 and P/N 08-1300-60-500, are standard on all PTFE-fitted pumps.

¹PTFE diaphragm, P/N 08-1010-55, must be used with Neoprene back-up diaphragms, P/N 08-1060-51.

SECTION 10B – ACCU-FLO™

ELECTRICAL REFERENCE

NEMA 4 COIL OPTIONS / UL / CSA (Item 3)

Part Number	Voltage ±10%			Power (W) ±10%	Current (A)			Resistivity (Ω)
	DC	AC			DC	AC		
		60 Hz	50 Hz			Inrush	Holding	
00-2110-99-150	24	48	44	4.8	.20	.20	.20	121
00-2110-99-151	12	24	22	4.8	.40	.40	.40	32
00-2110-99-155	60	120	110	4.8	.08	.08	.06	840

NEMA 7 COIL OPTIONS / UL / CSA (Item 3)

Part Number	Voltage ±10%			Power (W) ±10%	Current (A)			Resistivity (Ω)
	DC	AC			DC	AC		
		60 Hz	50 Hz			Inrush	Holding	
00-2110-99-153	12	24	22	7	.60	.55	.32	19
00-2110-99-154	24	48	44	7	.30	.30	.18	75
00-2110-99-156	60	120	110	7	.12	.13	.06	475

INTERNATIONAL EXPLOSION PROOF / CENELEC / PTB FILE # EX-91.C.2027

Part Number	DC Voltage ±10%	Power (W) ±10%	Current (A)		Resistivity (Ω)
			Inrush	Holding	
00-2110-99-157	24	3.3	.135	.135	177

OPERATOR OPTIONS (Item 5)

Part Number	NEMA Rating
00-2120-99	NEMA 4
00-2121-99	NEMA 7

WARRANTY

Each and every product manufactured by Wilden Pump and Engineering, LLC is built to meet the highest standards of quality. Every pump is functionally tested to insure integrity of operation.

Wilden Pump and Engineering, LLC warrants that pumps, accessories and parts manufactured or supplied by it to be free from defects in material and workmanship for a period of five (5) years from date of installation or six (6) years from date of manufacture, whichever comes first. Failure due to normal wear, misapplication, or abuse is, of course, excluded from this warranty.

Since the use of Wilden pumps and parts is beyond our control, we cannot guarantee the suitability of any pump or part for a particular application and Wilden Pump and Engineering, LLC shall not be liable for any consequential damage or expense arising from the use or misuse of its products on any application. Responsibility is limited solely to replacement or repair of defective Wilden pumps and parts.

All decisions as to the cause of failure are the sole determination of Wilden Pump and Engineering, LLC.

Prior approval must be obtained from Wilden for return of any items for warranty consideration and must be accompanied by the appropriate MSDS for the product(s) involved. A Return Goods Tag, obtained from an authorized Wilden distributor, must be included with the items which must be shipped freight prepaid.

The foregoing warranty is exclusive and in lieu of all other warranties expressed or implied (whether written or oral) including all implied warranties of merchantability and fitness for any particular purpose. No distributor or other person is authorized to assume any liability or obligation for Wilden Pump and Engineering, LLC other than expressly provided herein.

PLEASE PRINT OR TYPE AND FAX TO WILDEN

PUMP INFORMATION			
Item # _____		Serial # _____	
Company Where Purchased _____			
YOUR INFORMATION			
Company Name _____			
Industry _____			
Name _____		Title _____	
Street Address _____			
City _____		State _____	Postal Code _____
Country _____			
Telephone _____		Fax _____	E-mail _____
Web Address _____			
Number of pumps in facility? _____		Number of Wilden pumps? _____	
Types of pumps in facility (check all that apply): <input type="checkbox"/> Diaphragm <input type="checkbox"/> Centrifugal <input type="checkbox"/> Gear <input type="checkbox"/> Submersible <input type="checkbox"/> Lobe			
<input type="checkbox"/> Other _____			
Media being pumped? _____			
How did you hear of Wilden Pump? <input type="checkbox"/> Trade Journal <input type="checkbox"/> Trade Show <input type="checkbox"/> Internet/E-mail <input type="checkbox"/> Distributor			
<input type="checkbox"/> Other _____			

ONCE COMPLETE, FAX TO (909) 783-3440

NOTE: WARRANTY VOID IF PAGE IS NOT FAXED TO WILDEN

WILDEN PUMP & ENGINEERING, LLC